

Comunicaciones Móviles

Sistemas de Traceo

Area de Ingeniería Telemática
<http://www.tlm.unavarra.es>

Area de Teoría de la Señal y Comunicaciones
<http://csm.unavarra.es>

Tecnologías Avanzadas de Red
Grado en Ingeniería de Telecomunicación, 3º

Objetivos de esta Sección

- Enumerar los sistemas y servicios ofrecidos por sistemas de comunicaciones móviles
- Comprender la arquitectura de red y las funcionalidades (especialmente en capa física) que los caracterizan
- Analizar los datos en las correspondientes interfaces (A, Gb, Iub), como mecanismo de optimización de red en base a KPIs (Key Performance Indicators)

Monitorización de Calidad

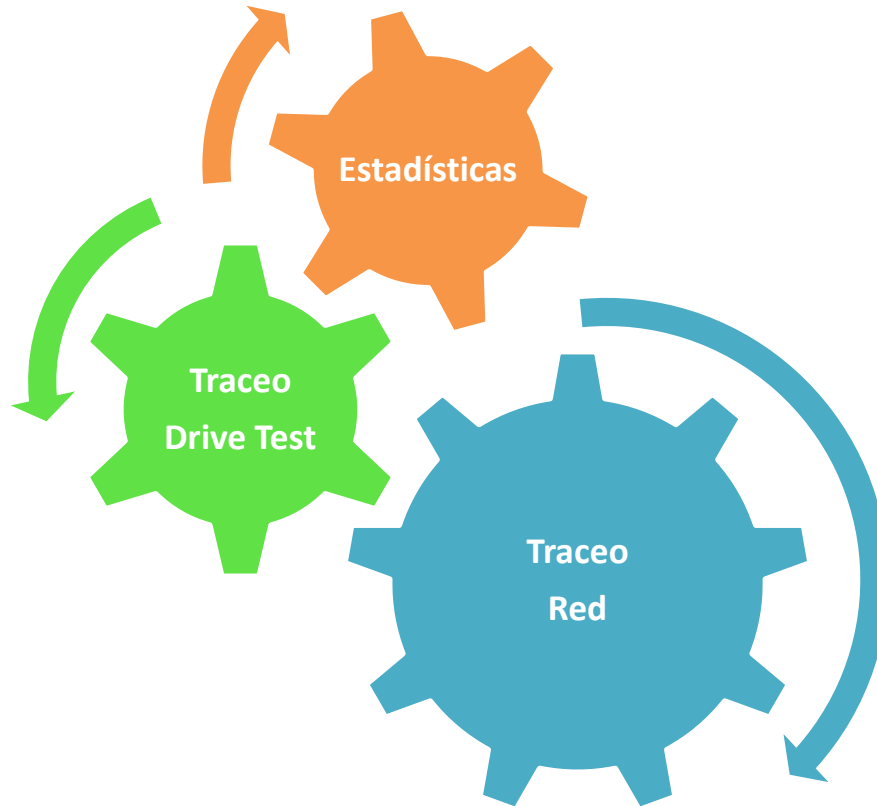

Abis
Gb
lub
lur
S/X



Elementos

R&S#T&SME measurement configuration with TETRA mobile.



ORDENADOR

SCANNER/BB

TERMINAL

ANTENA RF

ANTENA GPS

R&S ROMES4

Backpack:



User-specific tabling:



Floor plan display in hot spot mode:

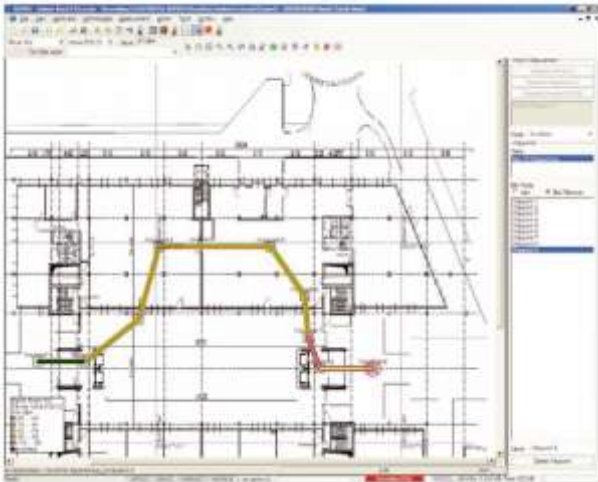

Test suitcase:



Tutirky test vehicle:



http://www2.rohde-schwarz.com/file_14130/ROMES4_dat_en.pdf

SWISSQUAL (R&S) DIVERSITY RANGER



TECHNOLOGIES
Extensive technologies support including: GSM, GPRS, EDGE, WCDMA, HSPA, LTE, CDMA2000, EVDO Rev A & Rev B, WIMAX, iDin and IS156.
SUPPORTED DEVICES
Extensive support of test devices including several handsets, USB and PCI Express data devices and RF scanners (PCTel SeeGull EX and EX mini).
SYSTEM ARCHITECTURE
Modular and scalable architecture adapted and optimized for portability and autonomy. Carrying frame with ergonomic design. Up to 4 compact PC modules supporting up to 8 test devices for a true benchmarking approach. Controlled with rugged and compact tablet PC over wireless connection.
PROTOCOL LAYERS
Full logging and decoding of multiple protocol layers on all technologies: GPRS and GPRS 2 RF, L2, L3, TCP/IP including PPP, RTP, WAP, SIP and more.
SERVICE TESTING OPTIONS
Test and benchmarking a wide range of services: - Voice telephony: CS & VoIP Speech Quality (narrow and wideband), noise suppression, Echo, RTT, DTMF - Data Ping, FTP, UDP, HTTP - Browsing: WAP, HTTP IE - Messaging: SMS, MMS, E-mail - Video streaming and media layer analysis: MPEG4, H.263, H.264 - Mobile TV: Video IP portals and YouTube - 3G Video telephony
SPEECH AND VIDEO QUALITY (MOS)
Wide range of integrated algorithm for voice and video intrusive and non-intrusive MOS assessments: - ITU-T and SwissQual POLQA - ITU-T P.862/P.862.1 (PEAQ) for voice MOS - SwissQual SQuad for intrusive voice (narrow & wideband), echo, noise suppression and RTT assessments - SwissQual NINa+ for non-intrusive voice assessments - SwissQual VQuad and VMon for video and multimedia MOS assessments, also featuring audio-visual synchronization assessment
TEST EXECUTION
Intra module communication allow parallel task starting and stopping synchronous on all channels. Each PC module can control multiple devices each capable of running Single, Parallel or Multi-RAB/DTM execution. User-Agent handset emulation for data testing.

DATA ACQUISITION
Patent-pending data reduction technology to reduce file size for optimized data upload.
CONTROL & ANALYSIS
Probe configuration, test execution, probe status monitoring, real-time measurements display, replay, data post-processing provided by the NetQual TestManager and NQView applications running on the control PC.
USER INTERFACE
Predefined and customizable workspace pages and monitors. More than 900 measurement values available for customized presentation in maps, line charts, bar charts, list boxes and tables. Predefined and customizable events with audio.
POST PROCESSING PLATFORM
NetQual NQCI with in-depth data analysis, network troubleshooting, report generation and historical performance trending. Flexible and customizable data selection and filtering capabilities including time & data, network technology, operator, device type, map polygon regions, service quality threshold, layer 3 messages and much more. Customizable Excel reports based on KPI with a powerful report generator.
KPI ANALYSIS
More than 200 ETSI-compliant Key Performance Indicators available in real-time as well as in post-processing.
SERVICE ANALYSIS
Post-processing provides in-depth voice and video analysis using the unique SQuad, VMon and VQuad content based objective quality algorithms and data analysis based on correlation of information from Service and application layers down to RF.
WEB PLATFORM
NetQual NQWeb platform with distributed data management, presentation and corporate reporting.
WEIGHT
Depending on the system configuration. For a full 4-channel system with 8 test devices the weight is below 14 kg.
VIBRATION
Shock proven platform with military standard connectors and hard-disk. 30G 6ms Shock Operational, all axis (IEC/EN 60068-2-27)

TEMPERATURE
Conducted thermal control for no-dust intrusion. Operational temperature range: -10°C to +50°C. (IEC/EN 60068-2-1 and -2)
RAIN PROTECTION
According to IEC 60068-2-18
ELEVATION
0-6500 feet (0-2000 meters)
ELECTRICAL SPECIFICATIONS
Intelligent 1.2V powering concept with hot-swappable batteries for maximum operation/autonomy. Optional connection to external battery for in-vehicle use cases.
AUTONOMY
More than 5 hours autonomy with 4 measurement channels and 4 measurement-phones that can be extended with battery hot-swap. Audible alarm for battery voltage.
VEHICLE INSTALLATION
Options to power from a car battery. Using normal cigarette lighter outlet it will extend the autonomy, connected directly to the car battery it will even charge the internal batteries.
GPS
GPS receiver integrated in the controller base module the GPS information is distributed over the LAN to the connected computer modules.
PC MODULE
Dedicated PC board with Pentium Core Duo, 30 GB HDD or SSD storage drive and Windows XP Professional or Windows 7.
PHONE HOUSING
Phone interfaces with patented battery emulation, automatic power fault recovery, high mechanical stability phone cradle and external antenna low loss connectors.
DATA CARD RESET ADAPTER
Patented USB data-card recovery device to automatically reboot stuck devices.
PCI EXPRESS MODULE
Integrated slots for PCI Express modules with easy SIM card access from front panel.

SWISSQUAL (R&S) BENCHMARKER



Software specification

Control & Analysis

Probe configuration, test execution, probe status monitoring, real-time measurements display, replay, data post-processing provided by NetQual NCMware running on the control laptop PC.

Technologies

Extensive technologies support including: GSM, GPRS, EDGE, WCDMA, HSPA+, HSPA-DC, LTE, CDMA/EVDO, WMAX, GSM, IS-95, ISM, PSTN and Ethernet.

Supported Devices

Support of more than 100 test devices including: Android smartphones (Samsung, HTC), standard hardware (J2, Samsung, Nokia, and Motorola), data devices (Zuwei), Sierra Wireless, ZTC, Pentacore, SIP clients (Sipgate, Counterpath), FE-scanners (MG TSMW), PC/UE SaaS/GUI ML, G+, G+, G+, and LX), GSM/PSTN boards (Dcom) and LAN adapters.

System Architecture

Modular and scalable architecture. Up to 8 PC modules each supporting up to 4 test devices for a true benchmarking approach. Controlled with local control laptop PC or remotely.

Protocol Layers

Full logging and decoding of multiple protocol layers on all technologies: GPP and 3GPP/2G, L2, L3, TCP/IP including PPP, RTP, SIP and more.

Service Testing options

- Test and benchmarking a wide range of services:
- Voice: VoIP, CS & VoIP Speech MOC, Noise suppression, Active & Passive Echo, Round Trip Time
- Data: Ping, FTP, UDP, HTTP, Data Capacity, Jitter
- Streaming: WAP, HTTP/S
- Messaging: SMS, MMS, E-mail
- Video over IP: Video streaming portals including YouTube supporting MPEG4, H.263 and H.264 streams with resolutions from QCIF up to 720p HD
- Video, Data, Voice and Messaging testing stacks running on Android

Speech Quality

- Wide range of integrated algorithms for voice quality assessments:
- ITU-T P.503 (POLQA) full reference voice MOS (narrow & wideband)
- ITU-T P.503.2 (POLQA) full reference voice MOS (narrowband)
- SwissQual SDCQ full reference voice MOS (narrow & wideband), echo, noise suppression and RTT assessments
- SwissQual NRP: no reference voice MOS

Video Quality

- Full support for video service evaluation and visual quality assessment:
- Video service evaluation with access, completion and drop rates, time to first picture, long term freezing, IP statistics and degradation causes values
- SwissQual VQCQ full reference visual quality MOS
- SwissQual VQIN: no reference visual quality MOS

Data Acquisition

Patent-pending data reduction technologies to reduce file sizes for optimized data upload.

Test Execution

Intra-module communication and Multichannel operation mode allows test call setup being synchronous on all channels as well as providing test and reliable measurement task starting and stopping. Each PC module can control multiple devices each capable of running Single or Multi-RAT/OTM test execution. User-Agent handset emulation for data testing.

Hardware specification

Dimension

Depends on the system configuration. For a 4-channel system the dimensions are 46.3 x 24.9 x 25.1 cm (W x D x H)

Weight

Depends on the system configuration. For a 4-channel system the weight is 11.7 kg

Vibration

30g shock proven platform with military standard connectors and solid state hard disks. Built-in shock and vibration absorbers.

Temperature

Conducted thermal control for no-dust intrusion. Operational temperature range: -10°C to +50°C

Humidity

Operating relative humidity < 90% RH (non-condensing)

Elevation

0-4000 meters

Electrical Specifications

Direct powering from 12V vehicle battery for simplified car installation

UPS

UPS is integrated into the controller base module of the system to bridge power dips and execute soft-shutdown over longer times.

GPS

External USB GPS receiver with magnetic mount. The GPS receiver information is distributed over the LAN to all connected computer modules.

Computer Module

Standard PC board with Intel Ivy Bridge CPU, 4GB RAM, 64 GB SSD storage drive and Windows 7/8 Edition. Dual module connection. Reset adaptor available through the front panel high friction USB 2.0 data port.

Device Module

Smartphone and data card housing module with patented smartphone battery emulation for power control, highly stable phone cradle, and low loss external antenna connectors. Enclosed mechanical housing for RF shielding, dust intrusion minimization, and autonomous cooling. Both modules have a patented reset adaptor for fault recovery and a SIM slot accessible from the front panel for easy and rapid internal device SIM swap.

Universal device modules offer connectivity to smartphones, feature phones, embedded RF modules and USB data sticks.



Benchmarker II offers a wide range of interfaces such as USB 3.0 and Gigabit LAN.



Each processing module is now hot-swappable with soft-shutdown features.



Benchmarker II is fully 4G/LTE MIMO capable, and already - uniquely - prepared for LTE-Advanced.

New processing architecture makes it much easier and faster to upgrade to new processors.



Benchmarker II is more power efficient, relies on a smart 12Vdc powering concept, and can fit into a 19" inch rack.

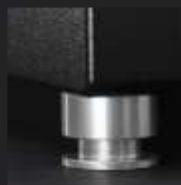

SW DE ANALISIS



SWISSQUAL NQI

FOCUS INFOCOM FIMAS

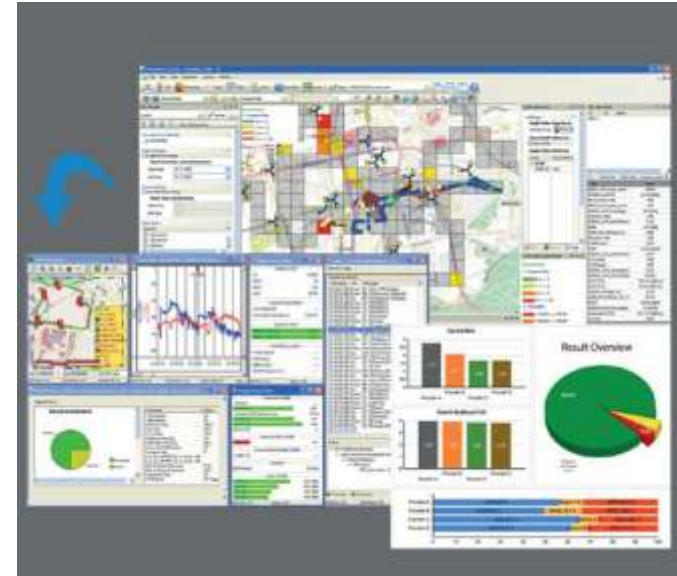

- Designed for speed & high data volumes
- Automatic data import
- Scalable multi-client post processing
- Geo Views with Visual Comparison mode
- Open Street Maps & Google Maps support
- One-click drill down
- Expert system for error classification
- Fully SQL-configurable views
- Professional web-based reporting

ASCOM TEMS



Sony Ericsson Xperia arc

TEMS POCKET 11.0 SPECIFICATIONS

Feature	TEMS Pocket 11.0
Mobile phone	Sony Ericsson Xperia arc
Operating System	Google™ Android™
Screen	4.2 inch, multi-touch
Positioning	Integrated aGPS
Networks	LT15i UMTS 900/2100 GSM GPRS/EDGE 850/900/1800/1900 LT15a UMTS 800/850/1900/2100 GSM GPRS/EDGE 850/900/1800/1900
Max Data Transfer	GSM GPRS 86 kbps, GSM EDGE 237 kbps UMTS HSUPA Cat6 (5.8 Mbps) UMTS HSDPA Cat8 (7.2 Mbps)
Connectivity	Bluetooth 2.1, WiFi 802.11 b/g/n
Chipset	Qualcomm 1GHz MSM8255

Redes Inalámbricas de Sensores

Libelium Smart World

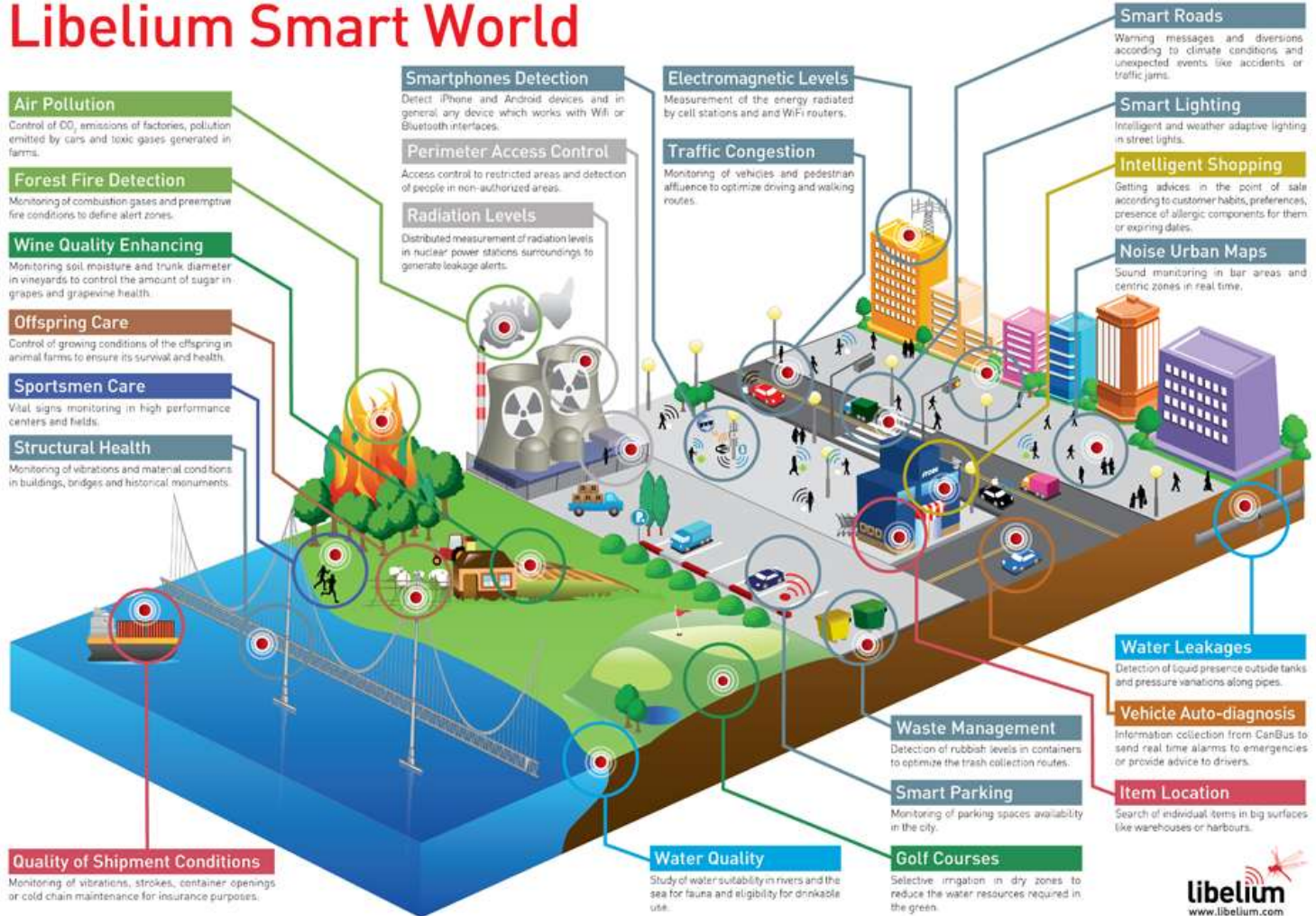

Redes Inalámbricas de Sensores

802154_zigbee_6lowpan.pcap 4 kb · 33 packets · more info

Filter: eth and eth and ip and udp and zep and wpan and wpan.frame_length and zbee_nwk

No.	Time	Source	Destination	Protocol	Length	Info
2	0.000024	0x0000	Broadcast	ZigBee	119	Command, Dst: Broadcast, Src: 0x0000
5	5.000976	0x0000	Broadcast	ZigBee	119	Command, Dst: Broadcast, Src: 0x0000
8	10.001115	0x0000	Broadcast	ZigBee	119	Command, Dst: Broadcast, Src: 0x0000
11	15.002605	0x0000	Broadcast	ZigBee	119	Command, Dst: Broadcast, Src: 0x0000
14	20.003919	0x0000	Broadcast	ZigBee	119	Command, Dst: Broadcast, Src: 0x0000
17	25.004461	0x0000	Broadcast	ZigBee	119	Command, Dst: Broadcast, Src: 0x0000
20	30.005801	0x0000	Broadcast	ZigBee	119	Command, Dst: Broadcast, Src: 0x0000
23	35.006218	0x0000	Broadcast	ZigBee	119	Command, Dst: Broadcast, Src: 0x0000
26	40.007164	0x0000	Broadcast	ZigBee	119	Command, Dst: Broadcast, Src: 0x0000
29	45.008254	0x0000	Broadcast	ZigBee	119	Command, Dst: Broadcast, Src: 0x0000
32	50.008927	0x0000	Broadcast	ZigBee	119	Command, Dst: Broadcast, Src: 0x0000

```

D Frame 2: 119 bytes on wire (952 bits), 119 bytes captured (952 bits)
D Ethernet II, Src: Icannlan_02:ff:ff:1d:00:00:5e:ff:ff:1d, Dst: Pegasus_28:47:a2 (08:00:17:28:47:a2)
D Internet Protocol Version 4, Src: 192.168.0.101 [192.168.0.101], Dst: 192.168.0.107 [192.168.0.107]
D User Datagram Protocol, Src Port: zep (17754), Dst Port: zep (17754)
D ZigBee Encapsulation Protocol, Channel: 16, Length: 45
D IEEE 802.15.4 Data, Dst: Broadcast, Src: 0x0000
D [Frame Length: 45]
D ZigBee Network Layer Command, Dst: Broadcast, Src: 0x0000
  
```

- ▼ ZigBee Network Layer Command, Dst: Broadcast, Src: 0x0000
 - ▷ Frame Control Field: Command (0x1209)
 Destination: 0xffff
 Source: 0x0000
 Radius: 1
 Sequence Number: 209
 Extended Source: Ember_00:00:0d:c5:58 (00:0d:6f:00:00:0d:c5:58)
 - ▷ ZigBee Security Header

https://www.cloudshark.org/captures/36822505d7ab?filter=frame%20and%20eth%20and%20ip%20and%20udp%20and%20zep%20and%20wpan%20and%20wpan.frame_length%20and%20zbee_nwk

Redes Inalámbricas de Sensores

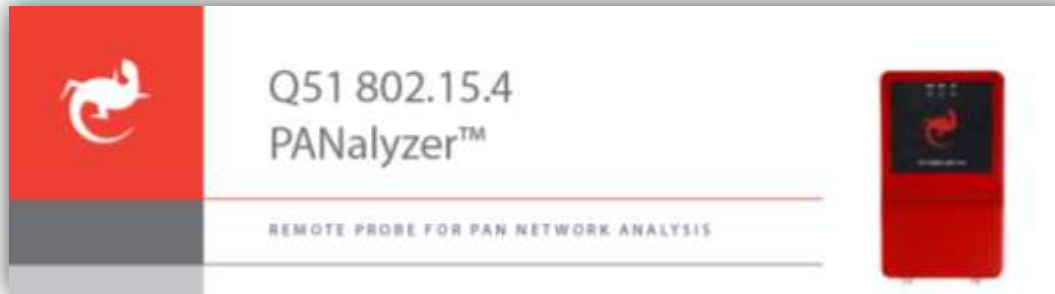

<http://www.exegin.com/hardware/q51app.php>



<http://www.ubisys.de/en/engineering/products-wireshark-802.15.4.html>

Medidas GSM

- Amplia aceptación de redes de comunicaciones móviles
- Sistema GSM limitado por
 - Interferencia (Relación C/I) (Norma GSM 05.05)
 - Cobertura
- Aumento de usuarios inevitablemente implica mayor nivel de interferencia
- Métodos para combatir este efecto:
 - Planificación
 - Activación de Funcionalidades
 - **Actuación sobre plan frecuencial**

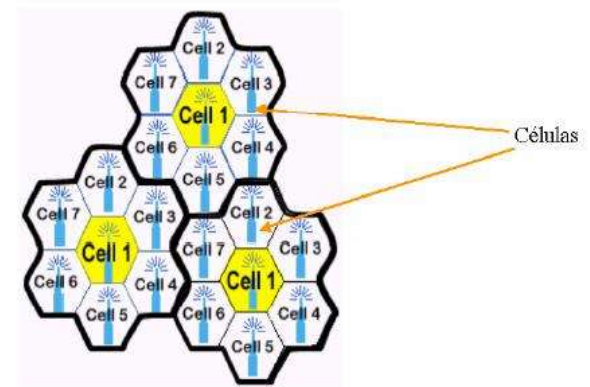

Medidas GSM

- **Plan frecuencial: determina para una zona objetivo la asignación de espectro, con el objetivo de minimizar interferencia.**
- **Dos casos diferenciados:**
 - **Frecuencias BCCH (máxima ortogonalidad)**
 - **Frecuencias TCH (menos restrictivo)**
 - **Salto RF (Hopping Sintetizado)**
 - **Salto Banda Base**
- **Una adecuada selección del plan frecuencial en BCCH determina en gran medida los índices de calidad de las células afectadas.**

Análisis de Interferencias

- Métodos para analizar interferencia:
 - Estadísticas de elementos de red (OMC)
 - Drive Test
 - Tranceo (Interfaz A-bis)
 - Medida directa en antena

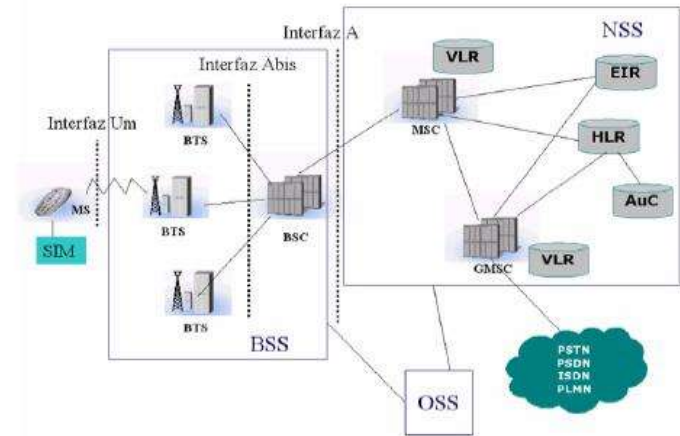

Análisis de Medidas

- **Medida en boca de antena**
 - Ofrece una imagen real del uso de espectro en la zona de influencia del sistema radiante.
 - Se trata de una medida “invasiva”, implicando un breve corte de servicio.
 - Adicionalmente, se comprueba la bondad del sistema radiante (e.g., medida de ROE).

Análisis de Medidas: Zona Objetivo

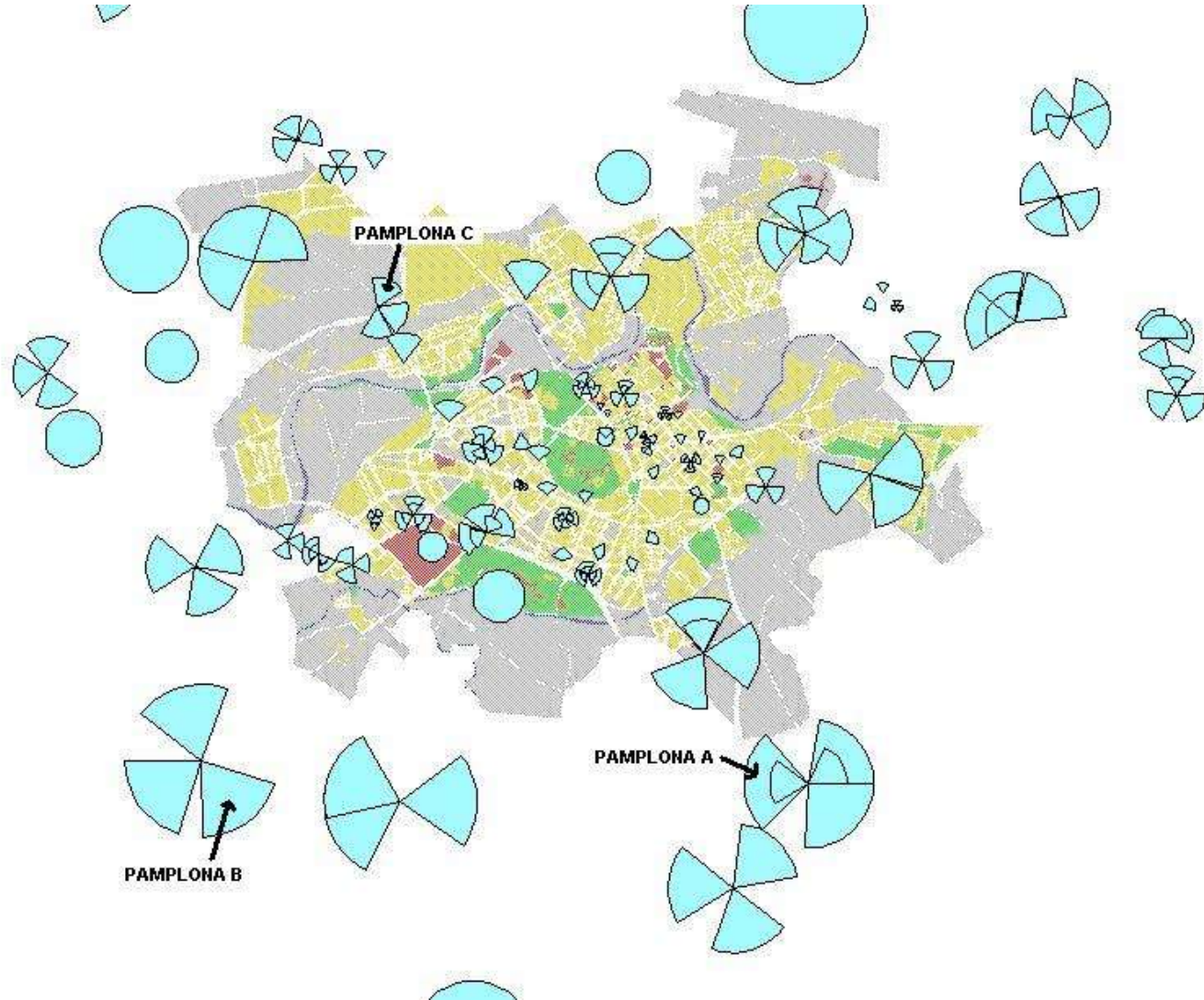

Análisis de Medidas: Sistema Radiante



Análisis de Medidas: Método de medida

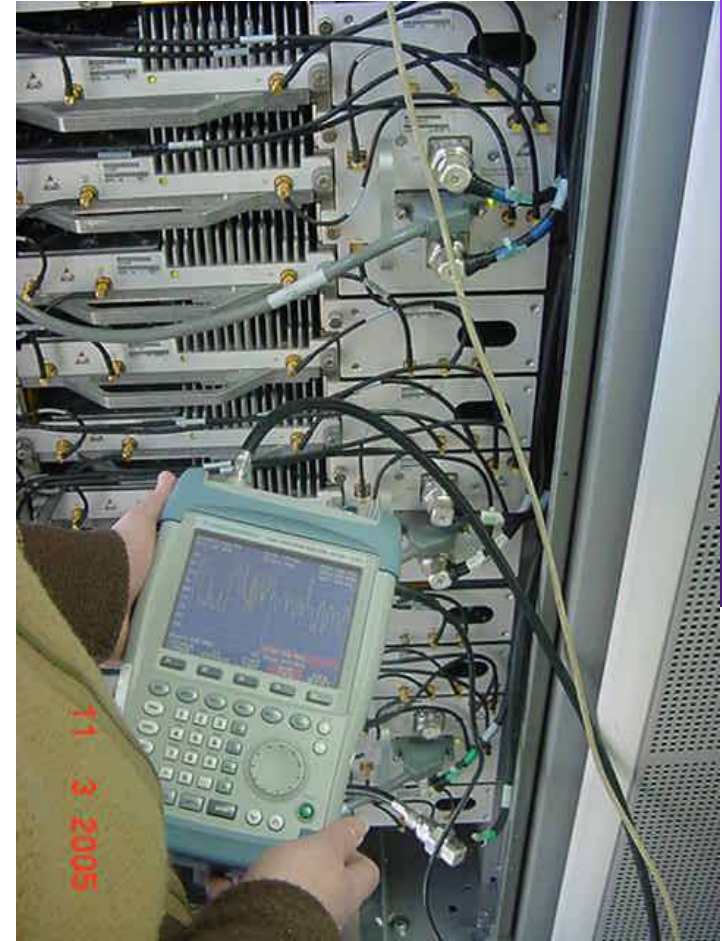
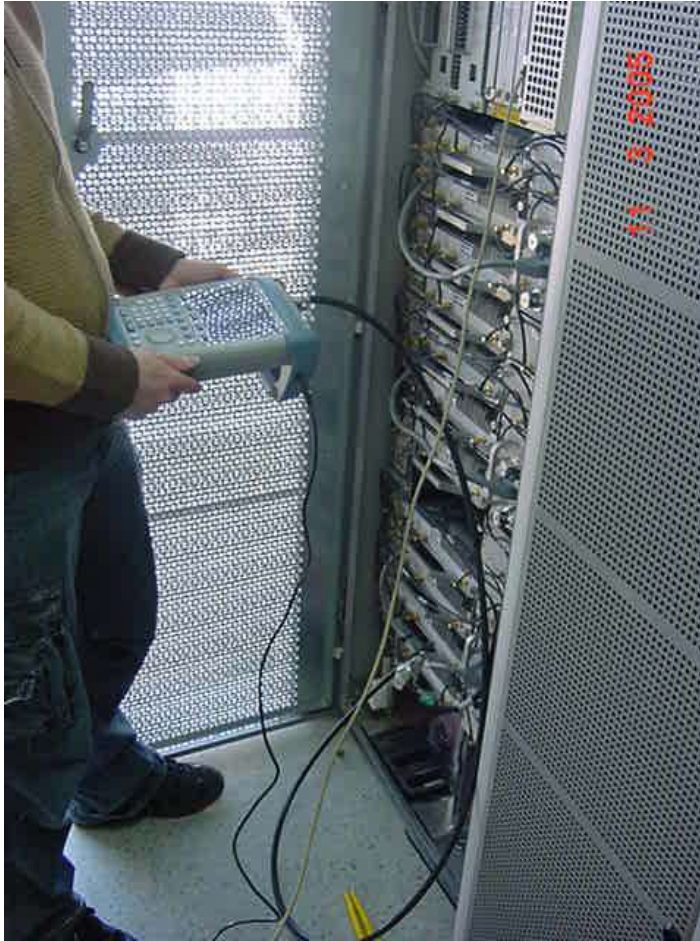

Análisis de medidas (1)

Célula A: boca 1

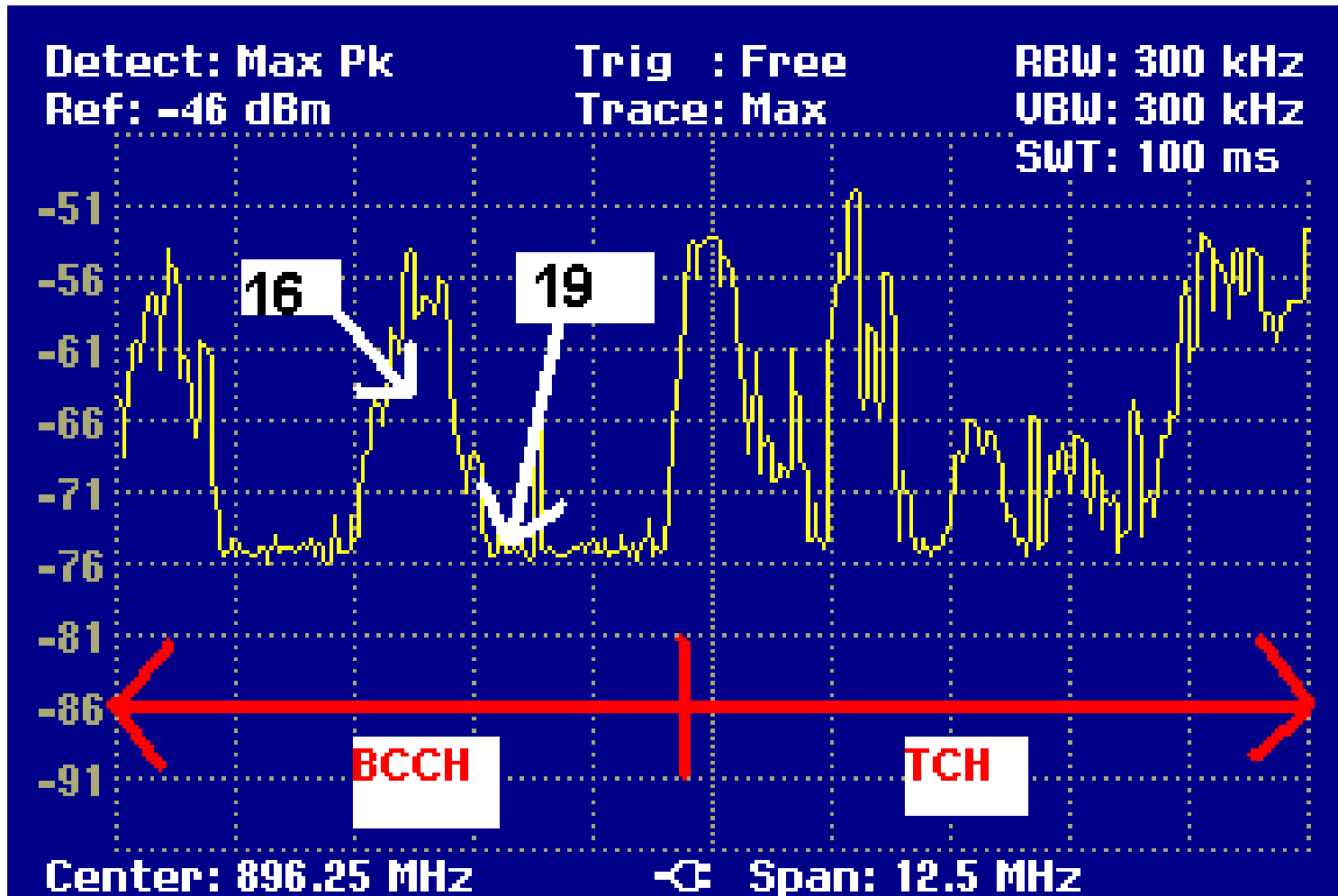

Análisis de medidas (2)

Célula B: boca 1

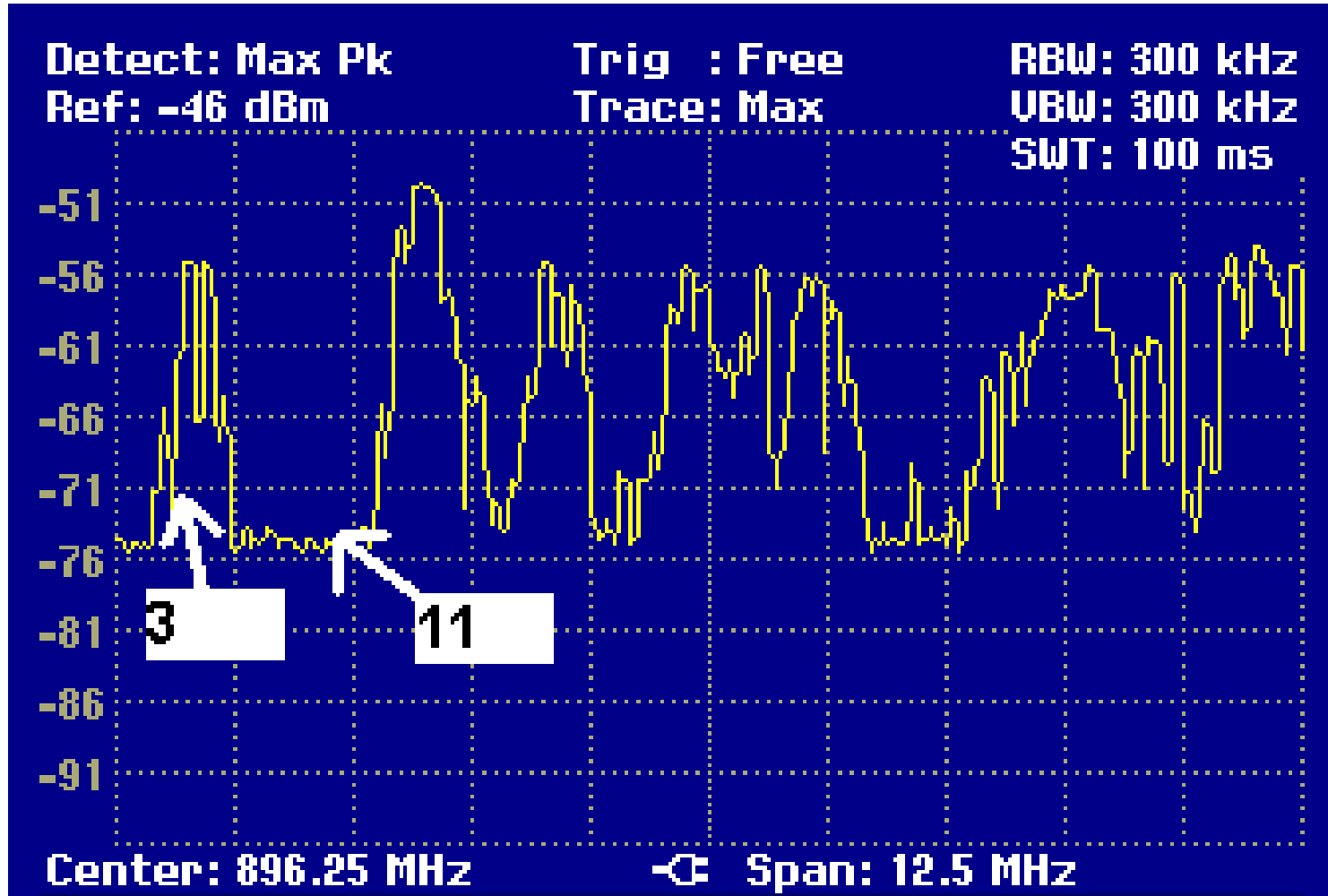

Análisis de medidas (3)

Célula C: boca 1

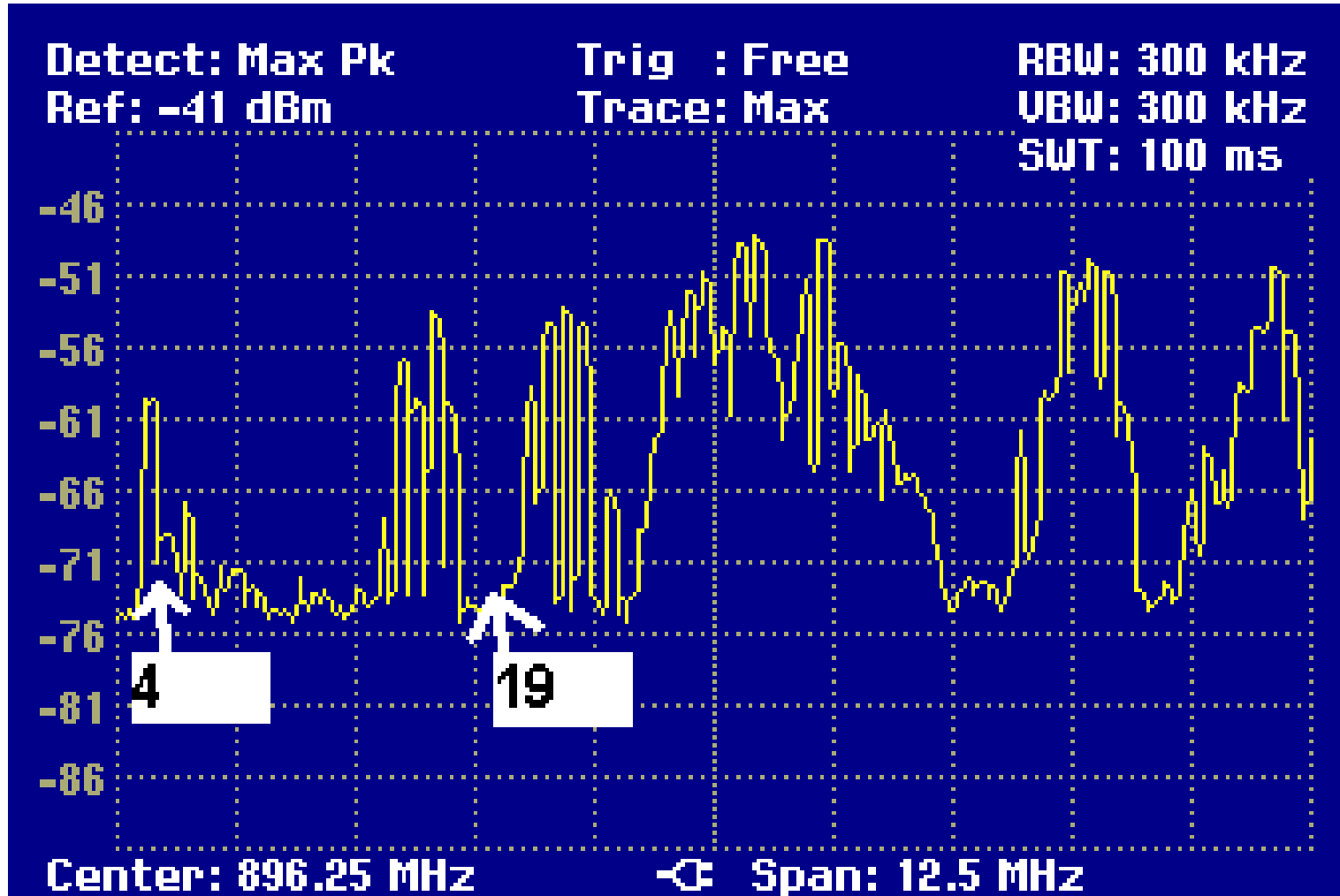

KPIs célula Pamplona A

Evolución del porcentaje de llamadas caídas del 18/03/2005 al 01/04/2005

% Llamadas caídas total

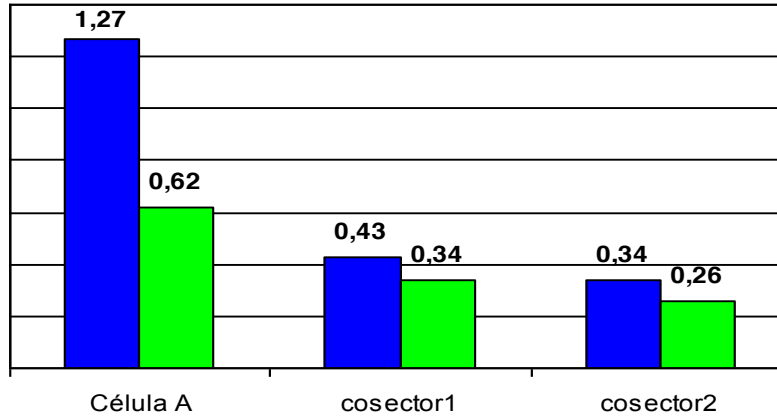

% Llamadas caídas radio

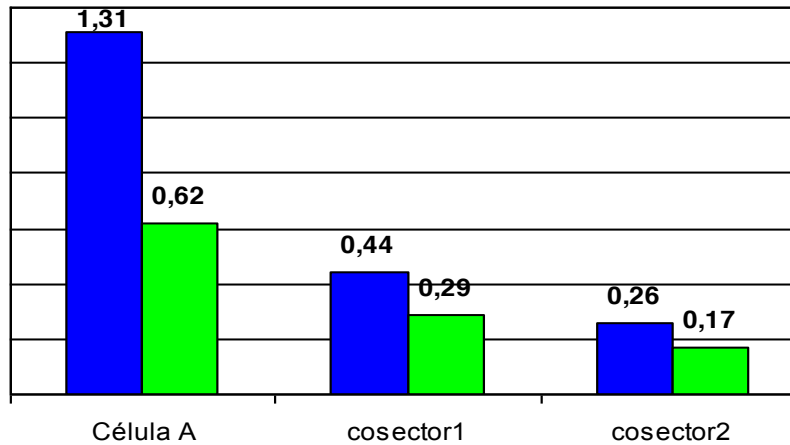

- Se observa mejoría en la célula
- Los dos cosectores también mejoran

KPIs célula Pamplona B

Evolución del porcentaje de llamadas caídas del 18/03/2005 al 01/04/2005

Evolución del porcentaje de llamadas caídas radio del 18/03/2005 al 01/04/2005

% llamadas caídas total

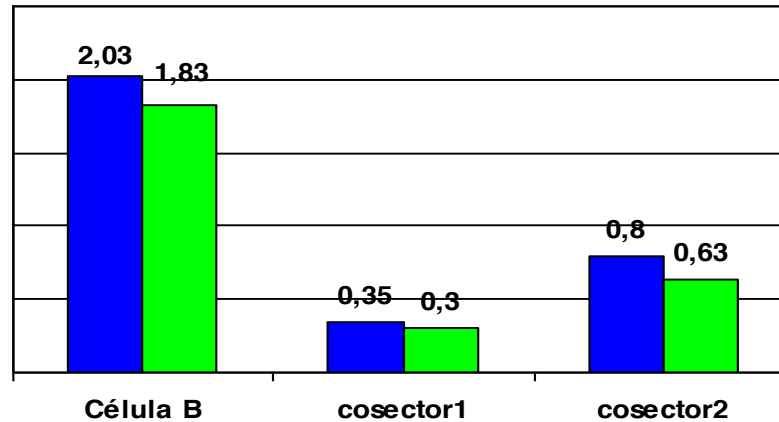

% llamadas caídas radio

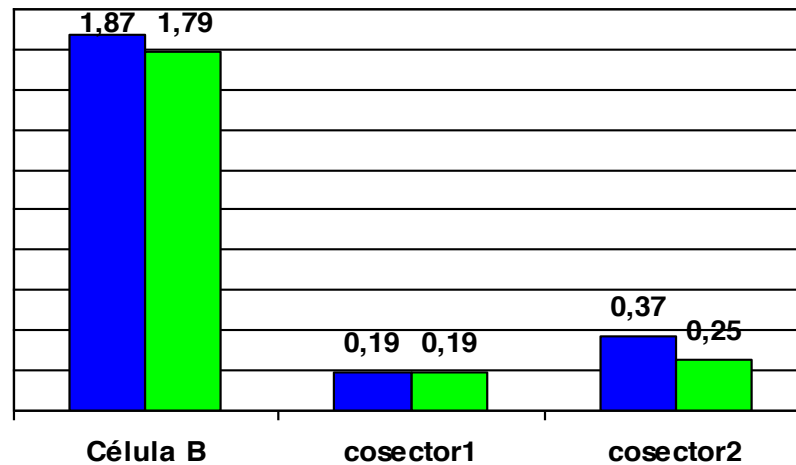

- La mejoría obtenida es menor que en el caso anterior
- Aún así, se sigue observando mejoría
- Los cosectores mejoran o no se ven afectados

KPIs célula Pamplona C

Evolución del porcentaje de llamadas caídas del 18/03/2005 al 01/04/2005

Evolución del porcentaje de llamadas caídas radio del 18/03/2005 al 01/04/2005

% llamadas caídas total

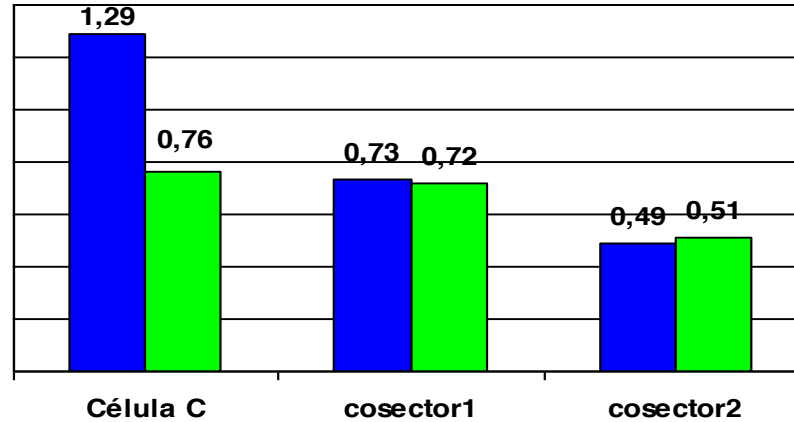

% llamadas caídas radio

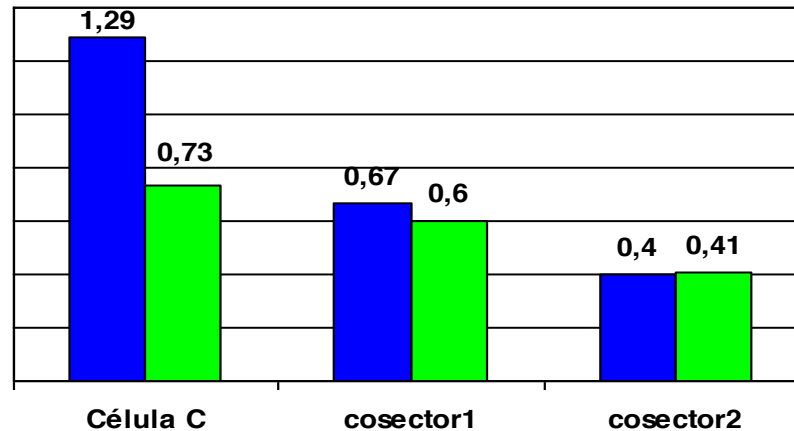

- Se observa mejoría en la célula
- Los dos cosectores no se ven especialmente afectados

UMTS: Estadísticas

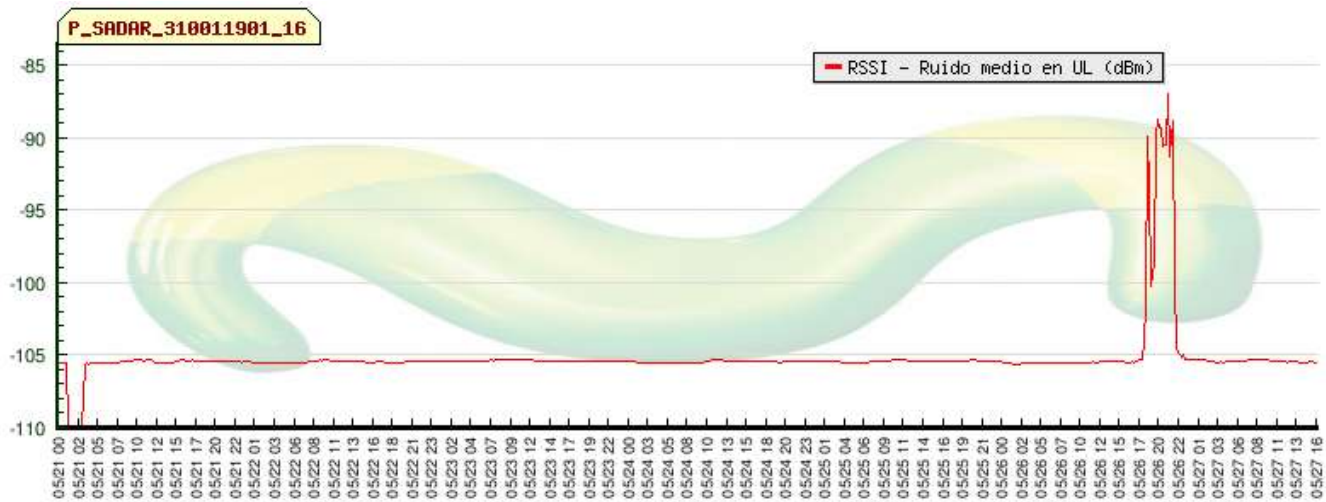
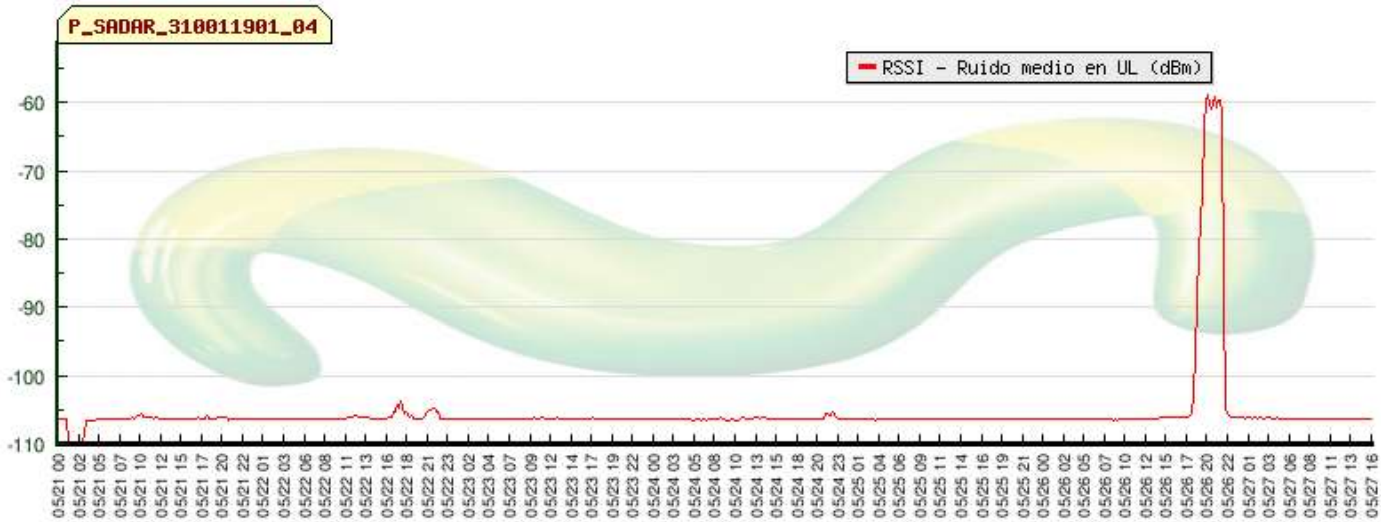

UMTS: Estadísticas

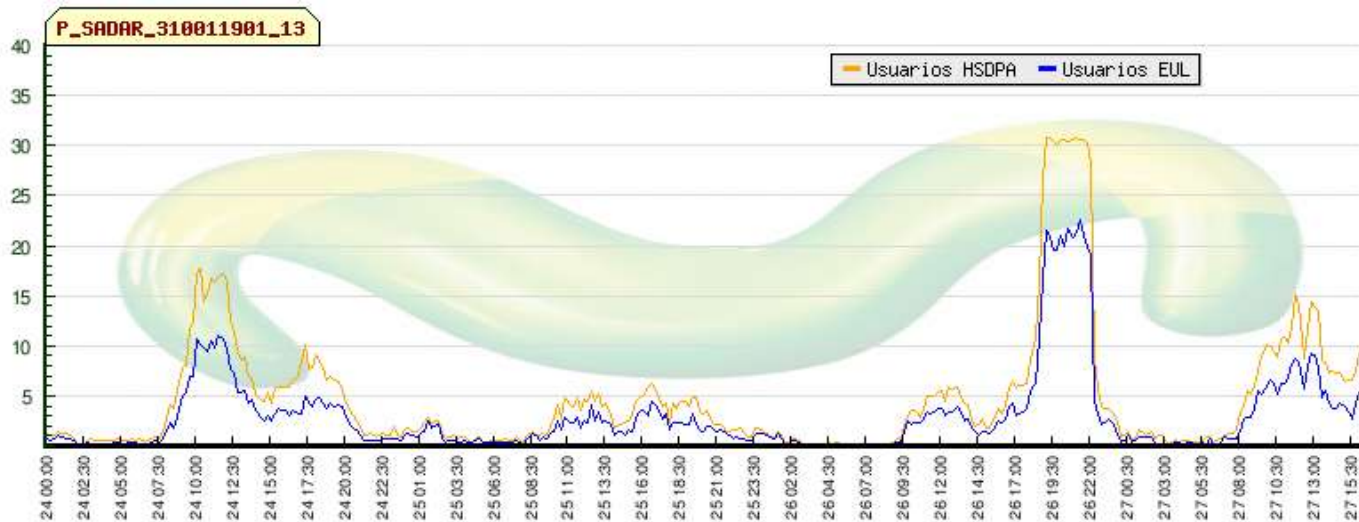
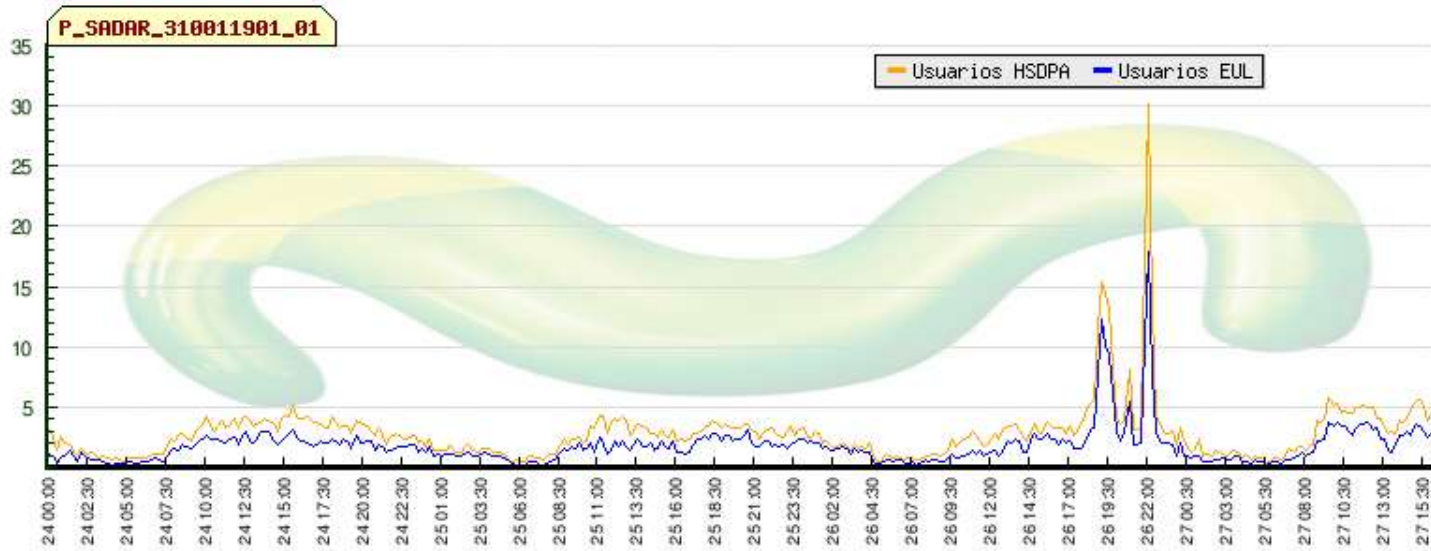

Medidas UMTS

Herramientas de medidas - Parámetros de medida 3GPP TS 25.215 :

– Referidas al canal piloto CPICH:

CPICH RSCP (CPICH Received Signal Code Power). Es la potencia recibida por el móvil en el canal de piloto. Las pérdidas del enlace L se calcula: $L = \text{Pot CPICH} - \text{RSCP}$

CPICH Ec/No Es la energía por chip dividido por la densidad de potencia de ruido en la banda. Se calcula teóricamente es: $\text{CPICH Ec/No} = \text{CPICH RSCP} / \text{RSSI}$.

– Referidas al canal de transporte:

BLER del canal de transporte. Es el numero de errores de bloque de transporte por unidad de tiempo, calculada en base al CRC de cada bloque.

Potencia transmitida del UE.

SIR. Es la relación señal a interferencia. Es igual a: $\text{SIR} = \text{SF} * \text{RSCP} / \text{ISCP}$

RSCP Es en este caso la potencia recibida en el canal de señalización (DPCCH) de nivel físico asociado al canal de datos (DPDCH), es decir, es la potencia que se esta empleando en el canal o código asignado.

ISCP (Interference Signal Code Power) Es la potencia de la señal de interferencia recibida en el canal de señalización DPCCH del código asignado, es decir, es la interferencia del canal.

Medidas UMTS

Herramientas de medidas - Parámetros de medida 3GPP TS 25.215 :

– Referidas al canal de transporte:

E_b/N_0 es la medida típica que se define en las herramientas de planificación, pero que en la práctica es difícil de medir directamente. Es la energía por bit de información dividida por la densidad de potencia. Es una relación señal a ruido pero del canal de datos DPDCH. Se puede estimar a partir de la SIR, SF, y otros parámetros

BER del canal de transporte. Es una estimación del error de bit del DPDCH.

BER del canal físico. Es una estimación del error de bit del DPCCH.

Potencia transmitida en un código. Es la potencia que el nodo B esta empleando en un código.

– Referidas al nodo B.

Potencia transmitida en la portadora. Es el cociente entre la potencia que actualmente esta transmitiendo en una portadora un nodo B y su máximo permitido.

UTRA RSSI (Received Signal Strength Indicator). Es la potencia recibida en toda la banda de la portadora servidora.

Medidas UMTS

Herramientas de medidas:

– Scanner, que permite realizar los siguientes tipos de medidas:

Análisis de espectro: Le permite al receptor funcionar como un sencillo analizador de espectro. El receptor permite escanear en la banda correspondiente al downlink UMTS.

Análisis de Códigos de Scrambling: El receptor es capaz de sincronizarse con la célula y realizar un análisis del canal piloto (CPICH) proporcionando su relación señal-ruido, nivel de potencia, grupo de código de scrambling, etc. Este análisis puede realizarse sobre los pilotos elegidos por el usuario o sobre los N mejores.

Medidas de canal: El receptor permite realizar medidas de canal con ancho de banda de 200 KHz y 3,84 MHz.

– Herramienta de medida de drive-test:

Permite recoger todos los parámetros de medida y de señalización de un terminal de modo ingeniería

Permite programar medidas de voz, datos y CS.

Permite exportar la medidas a tablas de texto.

Incorpora un escáner DTI con el que se puede hacer medidas simultáneas.

Permite realizar traspaso inter-RAT y recoger información.

Medidas UMTS

Análisis de los eventos



Un evento es el cumplimiento de unas condiciones de potencia y de tiempo marcados por UTRAN

Eventos Intra-frecuencia

- Evento1a → Añade una nueva célula
- Evento1b → Elimina una célula
- Evento1c → Reemplaza una célula
- Evento1d → Cambio de la mejor célula

Eventos Inter-frecuencia

- Evento 2d → Umbral otras tecnologías
- Evento 2f → Elimina mediciones

Eventos Inter-RAT

- Evento 3a → Cambio de tecnología

Eventos UE

- Evento 6a → Exceso de potencia
- Evento 6b → Elimina mediciones

Medidas

```
IntraFreqMeasQuantity1  
  filterCoefficient : fc22  
  modeSpecificInfo :  
  fdd intraFreqMeasQuantity-FDD :  
  cpich-Ec-N03  
  reportCriteria
```

```
  IntraFreqReportCriteria4 :  
    intraFreqReportingCriteria  
  intraFreqReportingCriteria  
  eventCriteriaList  
  IntraFreqEventCriteriaList :  
  [ 0 ] :  
    event
```

IntraFreqEvent : e1a⁵

```
  e1a  
  triggeringCondition :  
  detectedSetAndMonitoredSetCells  
  reportingRange : 6  
  w : 0  
  reportDeactivationThreshold : t2  
  reportingAmount : ra-Infinity  
  reportingInterval : ri1  
  hysteresis : 0  
  timeToTrigger : ttt100  
  reportingCellStatus  
  ReportingCellStatus :  
  allActivePlusMonitoredAndOrDetectedSet  
  allActivePlusMonitoredAndOrDetectedSet:  
  viactCellsPlus3  
  [ 1 ] :  
    event
```

IntraFreqEvent : e1b⁵

```
  triggeringCondition : activeSetCellsOnly  
  reportingRange : 10
```

```
  w : 0  
  hysteresis : 0  
  timeToTrigger : ttt640  
  reportingCellStatus  
  ReportingCellStatus : withinActiveSet  
  withinActiveSet : e3 [ 2 ] :  
  event
```

IntraFreqEvent : e1c³

```
  e1c  
  replacementActivationThreshold : t3  
  reportingAmount : ra-Infinity  
  reportingInterval : ri1  
  hysteresis : 2  
  timeToTrigger : ttt100  
  reportingCellStatus  
  ReportingCellStatus :  
  allActivePlusMonitoredAndOrDetectedSet  
  allActivePlusMonitoredAndOrDetectedSet:  
  viactCellsPlus3  
  [ 3 ] :  
    event
```

IntraFreqEvent : e1d⁵

```
  hysteresis : 15  
  timeToTrigger : ttt2560  
  reportingCellStatus  
  ReportingCellStatus :  
  allActivePlusMonitoredAndOrDetectedSet  
  allActivePlusMonitoredAndOrDetectedSet:  
  viactCellsPlus1  
  measurementReportingMode  
  measurementReportTransferMode :  
  acknowledgedModeRLC
```

Eve

Medidas intra frecuencia

MEASUREMENT CONTROL



UTRAN notifica al UE los criterios necesarios



Eventos para decisión de handover

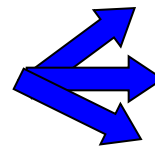

Reporting range

Time to trigger

Hysteresis

Ejemplo

Tres señales de diferentes células que dan servicio a un UE

Eventos 1a, 1b y 1c

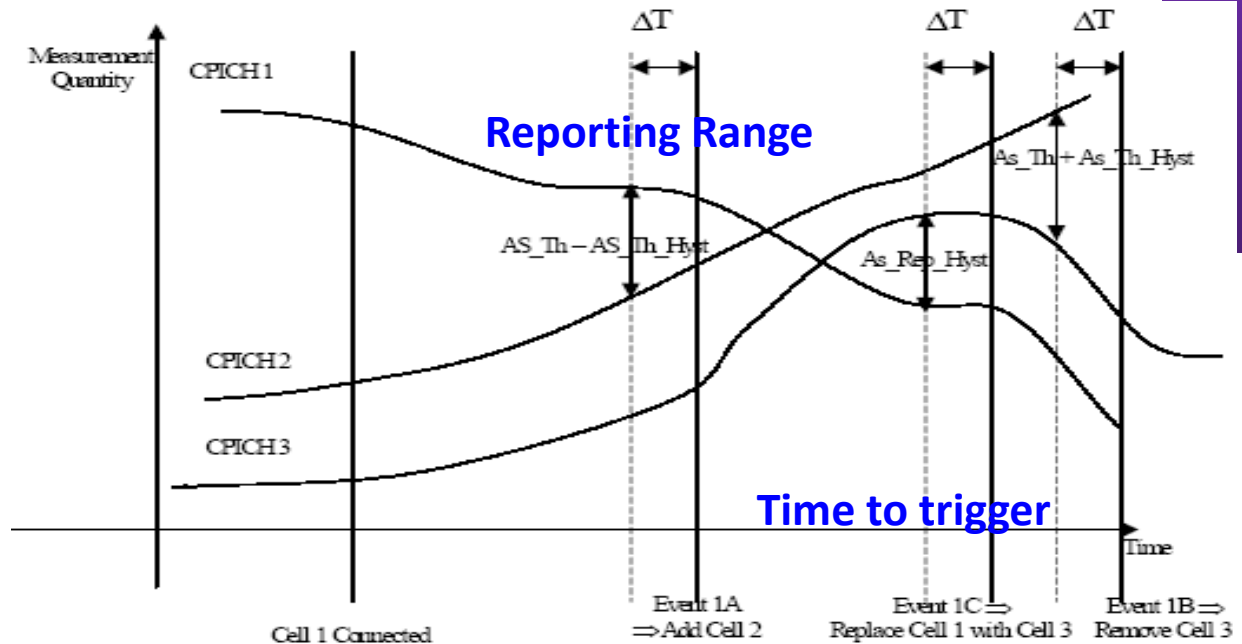

Evento

LLAMADA 3

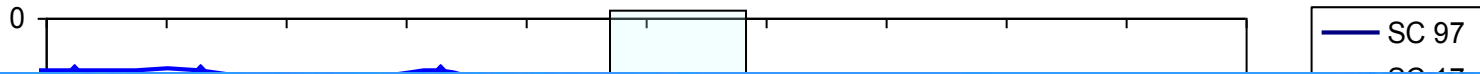

Serving/Active Set + Neighbors [MS1]						
Type	Cell name	SC	Cell ID	UARFCN DL	CPICH Ec/No	CPICH RSCP
AS		129	10838		-6.00	-85.00
MN		107	10838		-8.00	-87.00
MN		121	10838		-13.00	-92.00

Serving/Active Set + Neighbors [MS1]						
Type	Cell name	SC	Cell ID	UARFCN DL	CPICH Ec/No	CPICH RSCP
AS		129	10838		-7.00	-85.00
AS		107	10838		-8.00	-87.00
MN		121	10838		-13.00	-92.00

Se ha añadido una célula a la ventana del Active Set

42000 42500 43000 43500 44000 44500 45000 45500 46000 46500 47000

tiempo (ms)

llamada 7

0

Serving/Active Set + Neighbors [MS1]

Type	Cell name	SC	Cell ID	UARFCN DL	CPICH Ec/No	CPICH RSCP
AS		112	10838		-4.00	-75.00
AS		96	10838		-15.00	-87.00

Una célula ha salido del Active Set debido a los valores de CPICH Ec/No

Type	Cell name	SC	Cell ID	UARFCN DL	CPICH Ec/No	CPICH RSCP
AS		112	10838		-2.00	-73.00
MN		96	10838		-15.00	-87.00

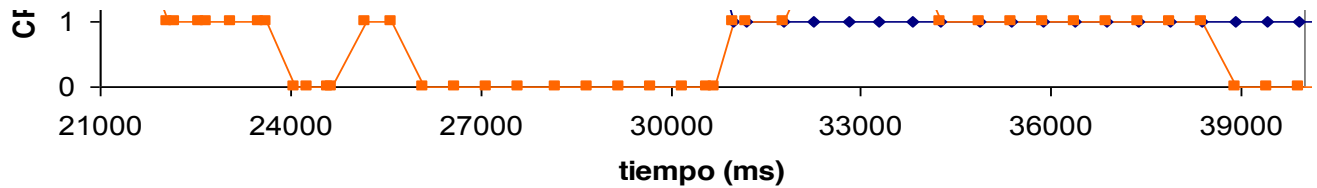

llamada 7

CPIC Ec/No

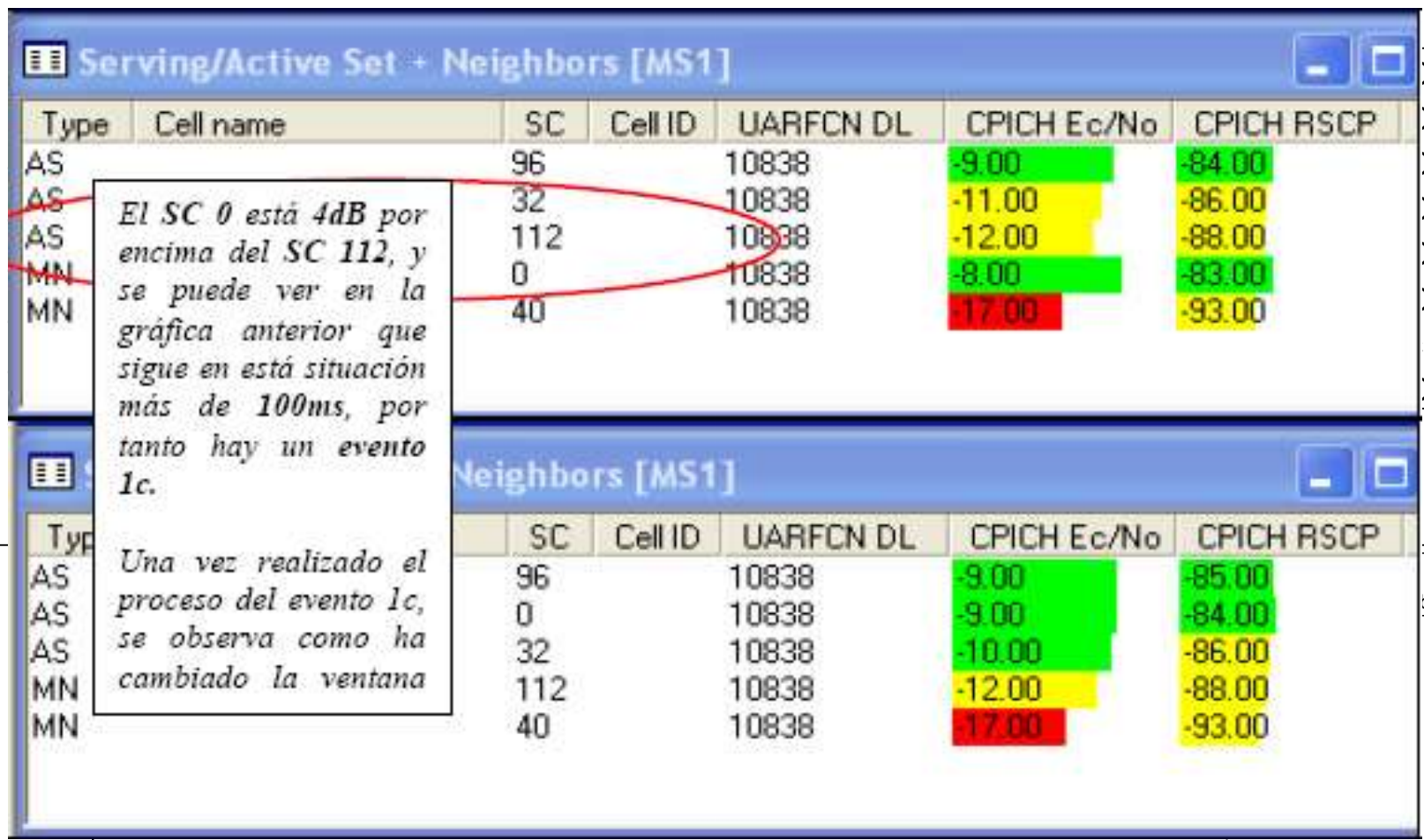

El SC 0 está 4dB por encima del SC 112, y se puede ver en la gráfica anterior que sigue en esta situación más de 100ms, por tanto hay un evento lc.

Una vez realizado el proceso del evento lc, se observa como ha cambiado la ventana

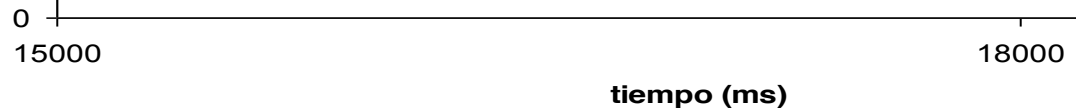

112
96
0
32
16
40
8
24

bour

Evento 1d

Cambio de la mejor célula

LLamada 1 15:14:02:58

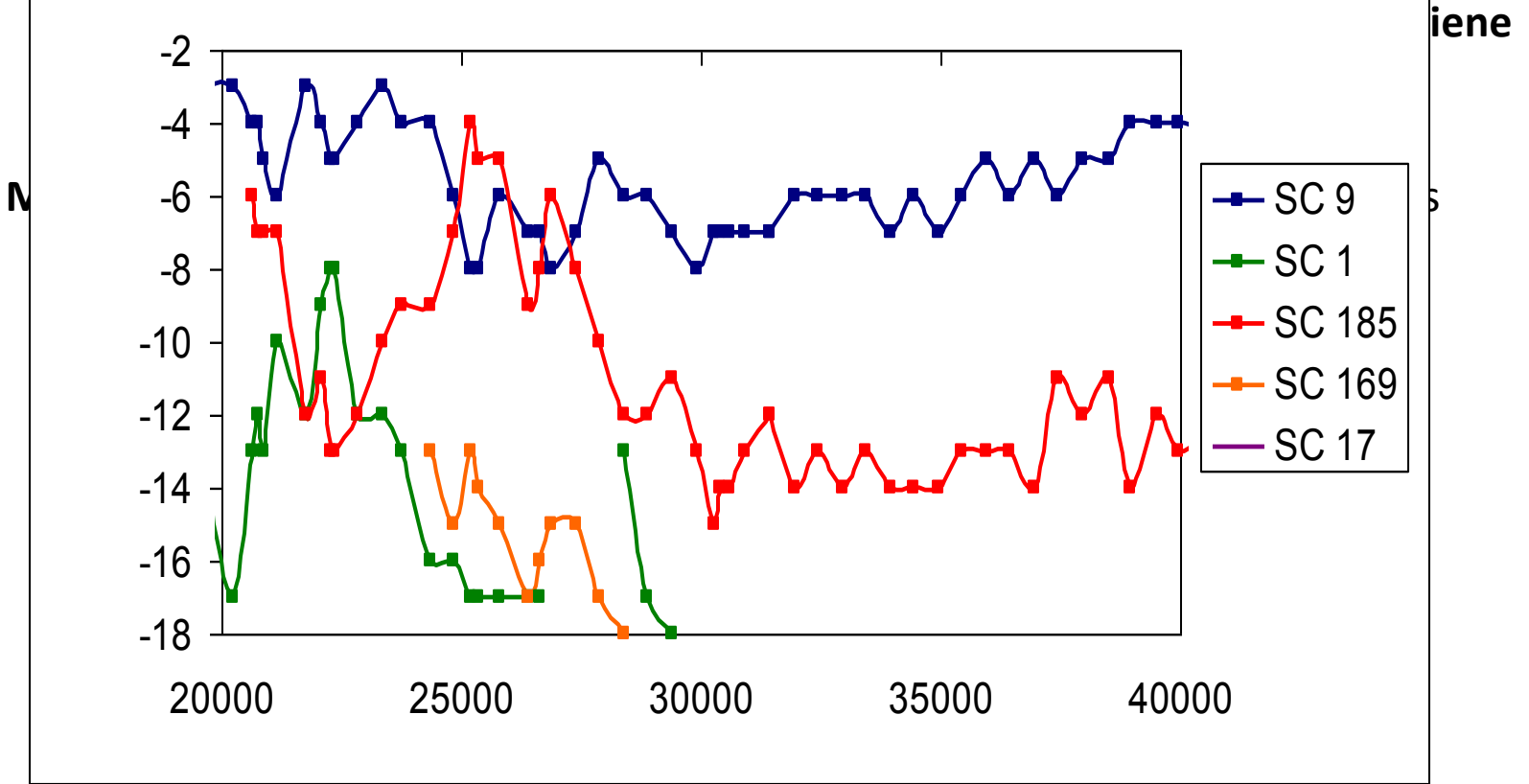

periodicalOrEventTrigger : eventTrigger

Informes periódicos en medidas intra-frecuencia

Fallo al añadir una célula

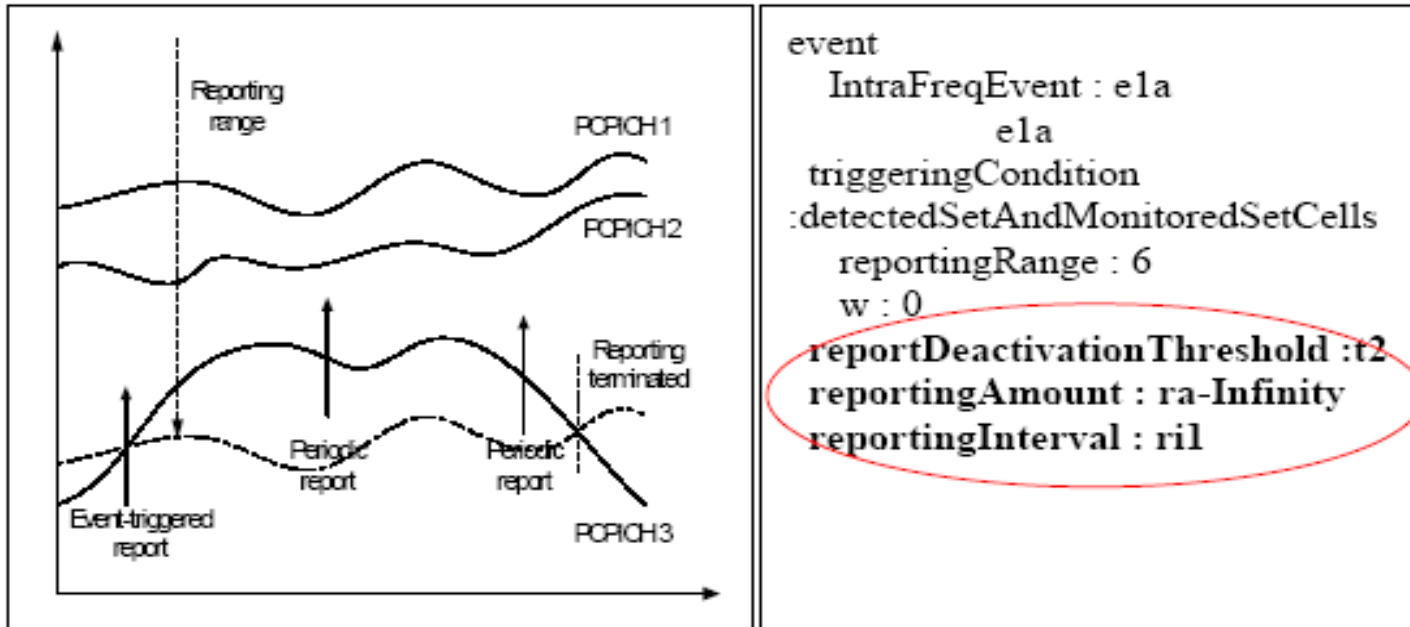

La repetición del envío del informe de medidas debe finalizar si:

- No hay ninguna célula que cumpla ya los criterios del evento1a
- UTRAN ha añadido un núm. máximo de células (**reporting deactivation threshold**)
- El UE ha enviado el número máximo de mensajes MEASUREMENT REPORT (**amount of reporting**)

Informes periódicos en medidas intra-frecuencia

Fallo al reemplazar una célula

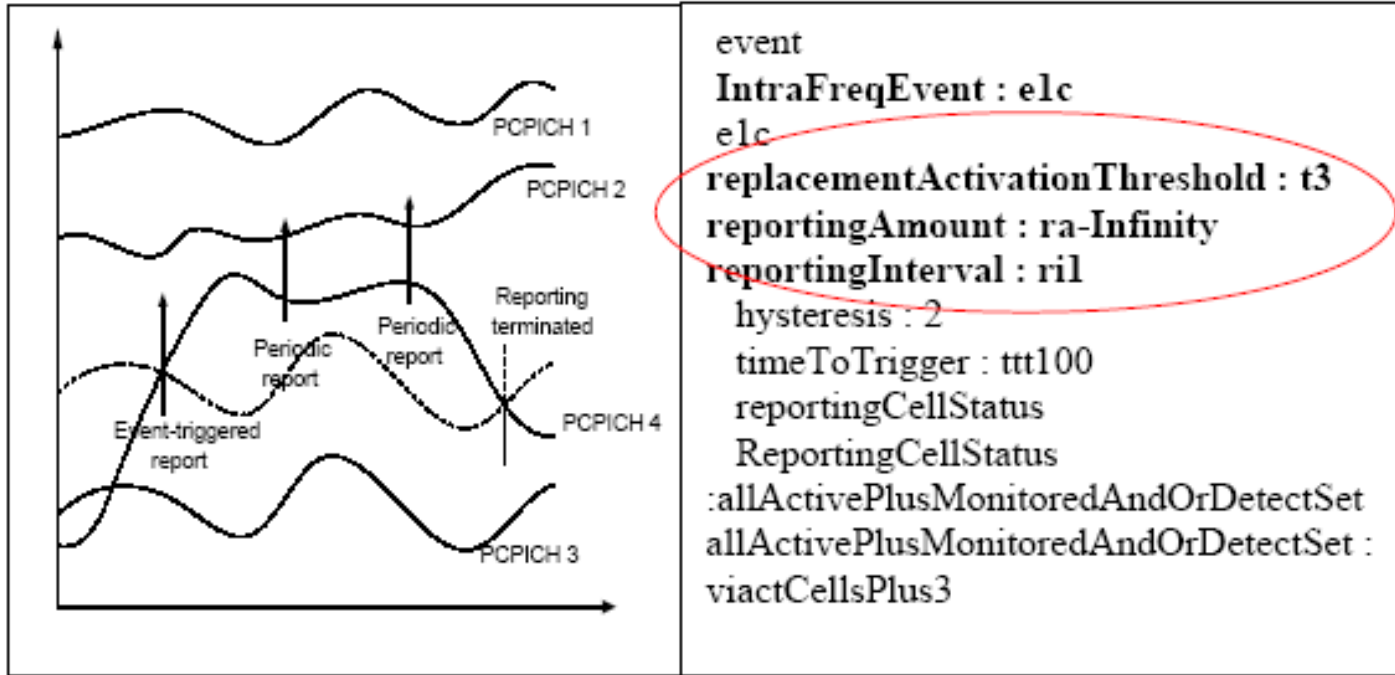

La repetición sucesiva del envío de informes deberá ser parado si:

- no existe ninguna célula que cumpla las condiciones de triggering del evento1c;
- UTRAN ha eliminado células del active set (**replacement activation threshold**); o
- el UE ha enviado el número máximo de mensajes MEASUREMENT REPORT (definido por el parámetro **amount of reporting**).

Mecanismos disponibles para una modificación en las medidas intra-frecuencia

Histéresis

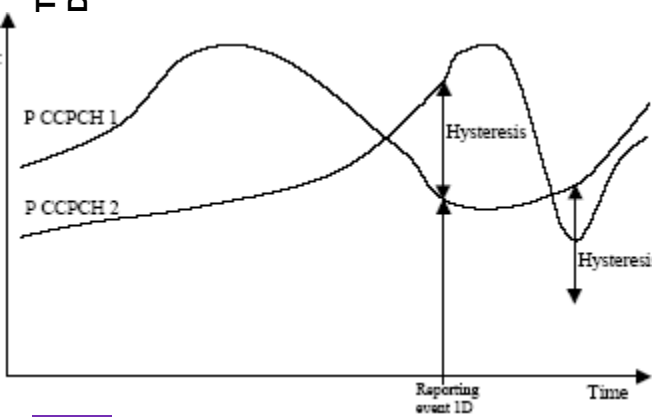

El valor de la histéresis asegura que no se informa del evento 1d (Primary_CPICH 2 llega a tener mejor nivel que 1) hasta que la diferencia sea igual al propio valor de histéresis.

Time To Trigger

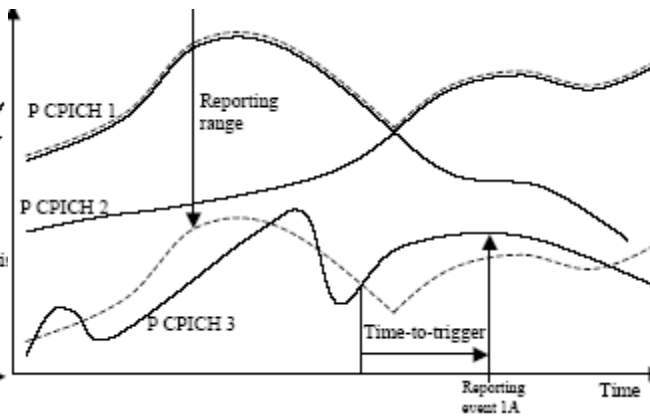

El efecto del time to trigger es el de exigir la permanencia de las condiciones de triggering durante un periodo de tiempo regulable a nivel de RNC para que un evento se produzca

Cell Individual Offset

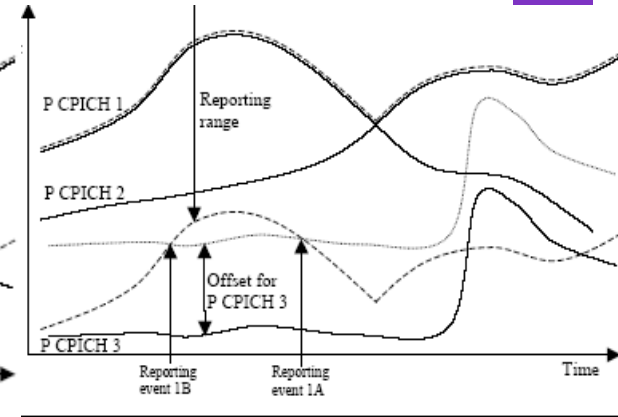

La técnica del offset puede resultar muy interesante si el operador conoce el comportamiento de una célula específica. Nivel de célula

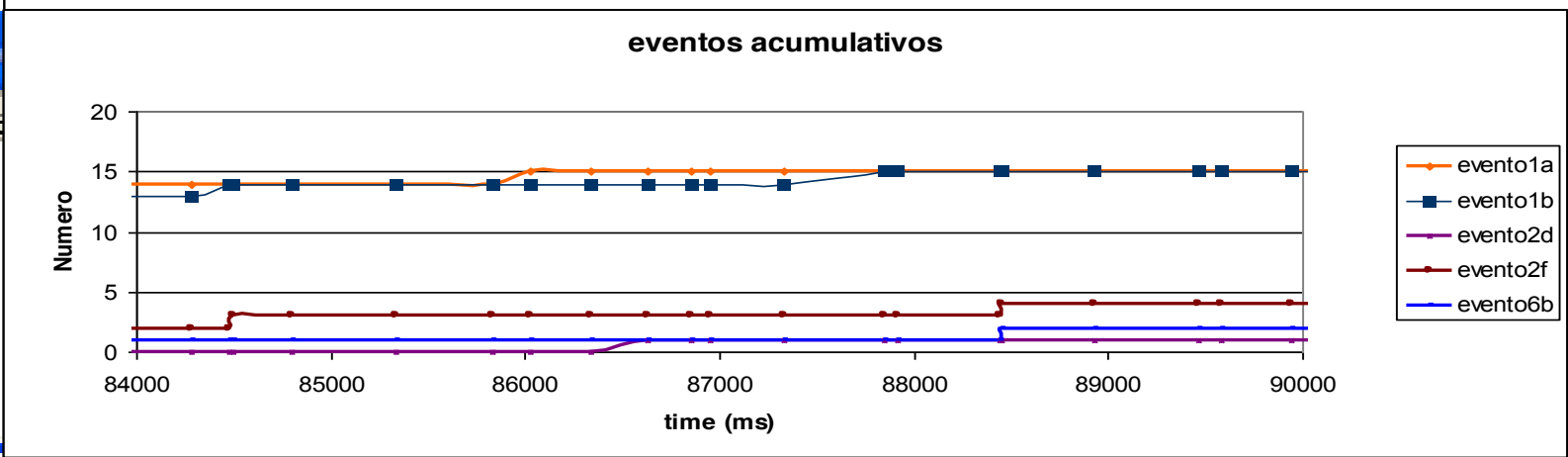
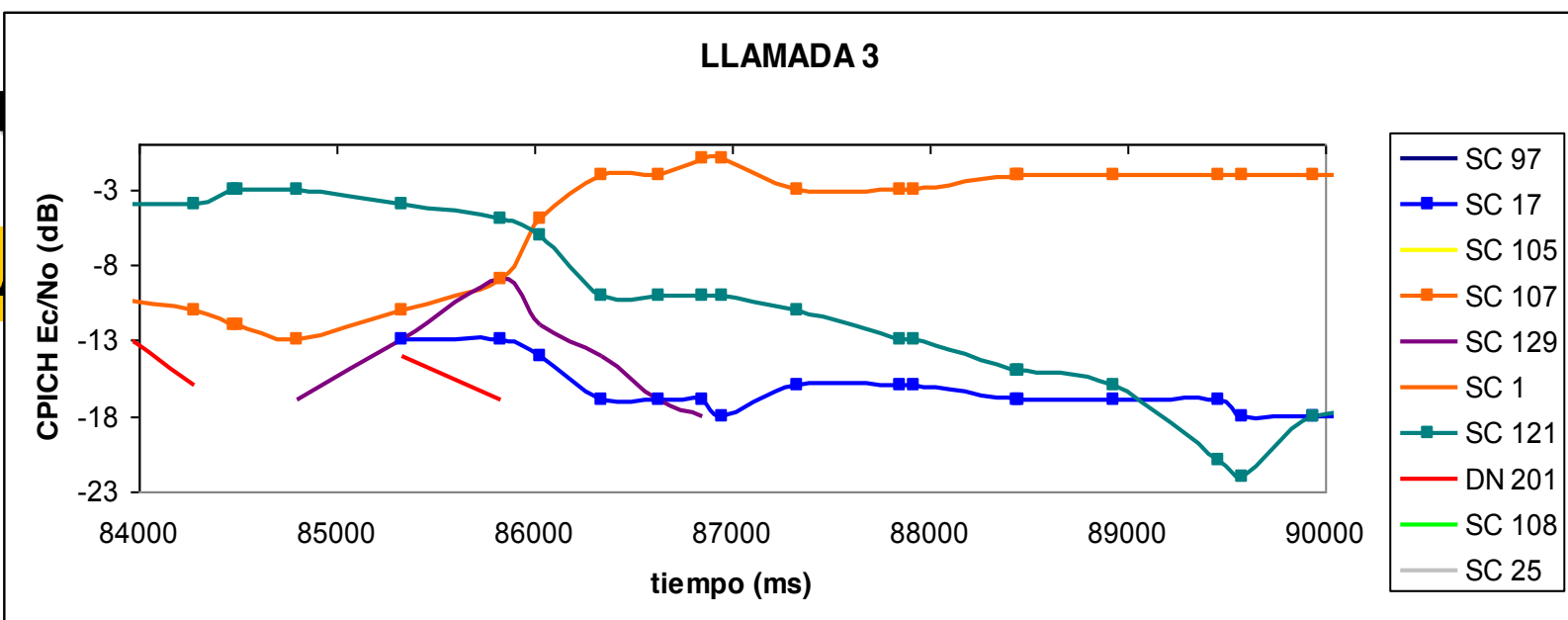

Measurement Control (DL-DCCH)

Time: 15:25:14.27
 Protocol Version nr : 2.0
 Report Id : (0) RRC Message Report
 Timestamp : 16379284
 Logical Channel : (0) DCCH
 Direction : (1) Downlink
 rrc-MessageSequenceNumber : 3
 MeasurementControl : r3
 measurementControl-r3
 rrc-TransactionIdentifier : 3
 measurementIdentity : 3
 measurementCommand
 MeasurementCommand : modify
 measurementType
 MeasurementType :
 interRATMeasurement
 interRATMeasurement
 interRATCellInfoList
 removedInterRATCellList
 RemovedInterRATCellList :
 removeNoInterRATCells
 newInterRATCellList
 NewInterRATCellList :
 [0] :
 interRATCellID : 11

technologySpecificInfo : gsm
 interRATCellIndividualOffset : 0
 bsic

ncc : 1
 bcc : 7
 frequency-band : dcs1800BandUsed
 bcch-ARFCN : 30
 reportCriteria
 InterRATReportCriteria
 interRATReportingCriteria
 interRATReportingCriteria
 interRATEventList
 InterRATEventList :
 [0] :
 InterRATEvent : event3a
 event3a
 thresholdOwnSystem : -11
 w : 0
 thresholdOtherSystem : -102
 hysteresis : 0
 timeToTrigger : ttt100
 reportingCellStatus
 ReportingCellStatus
 withinActSetOrVirtualActSet-InterRATcells
 withinActSetOrVirtualActSet-
 InterRATcells :

OMA
na
enos

Evento 3a

Medidas inter RAT (Radio Access Technology)

*Cuando la calidad estimada de una frecuencia en uso en una red WCDMA está por debajo de un umbral absoluto y el RSSI de una portadora de una célula GSM/GPRS está por encima de un umbral absoluto durante al menos un tiempo igual al `timeToTrigger`, se dice que se ha producido un **evento3a**.*

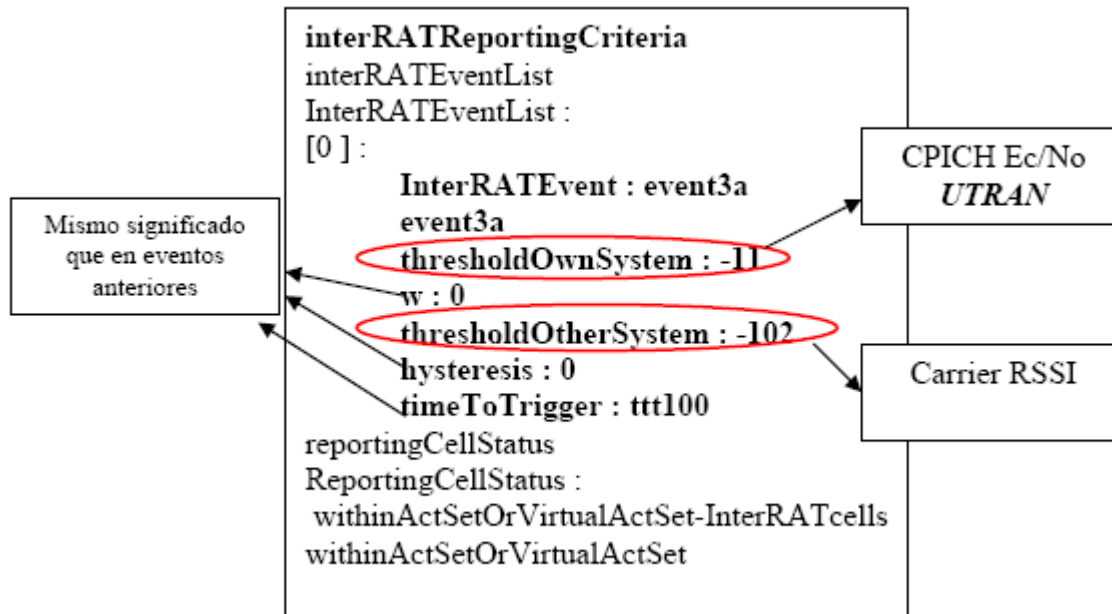



TEMS ERICSSON

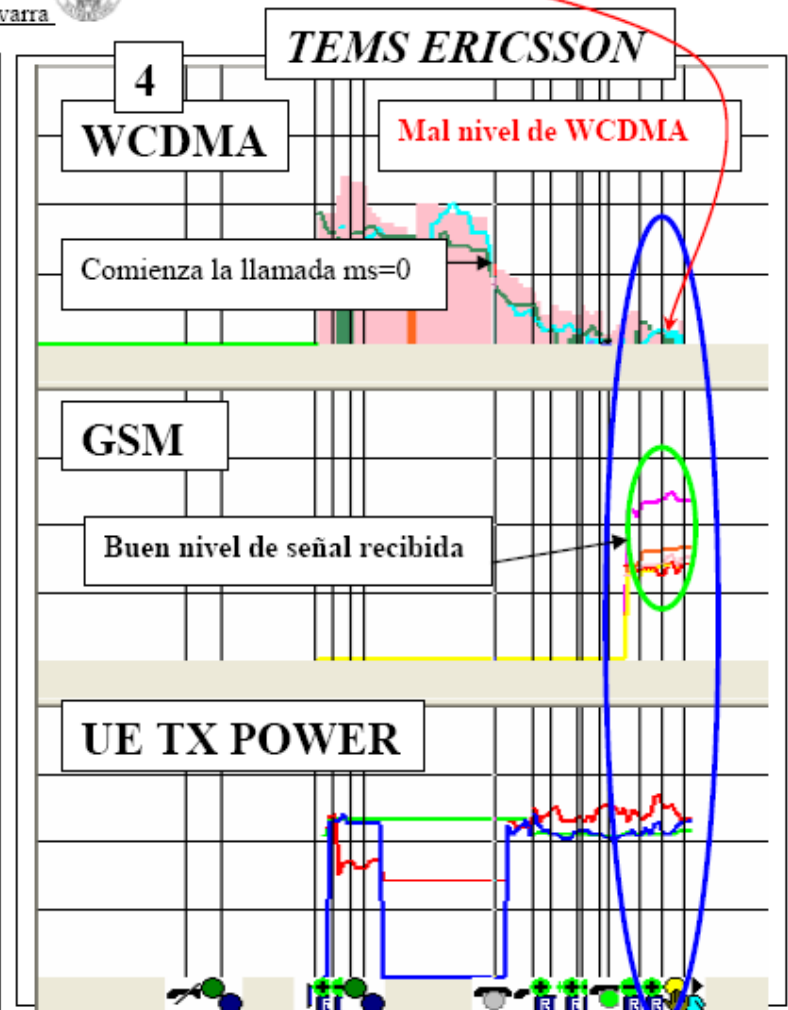
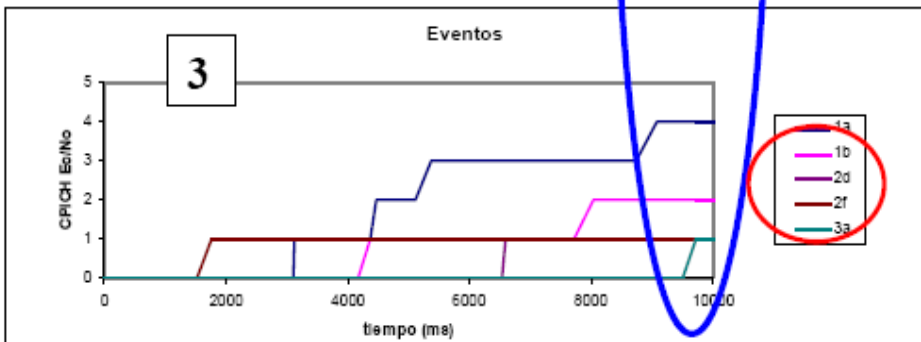
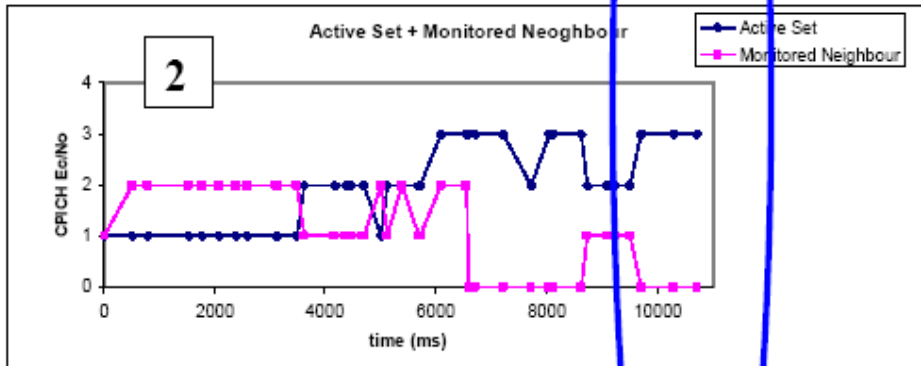
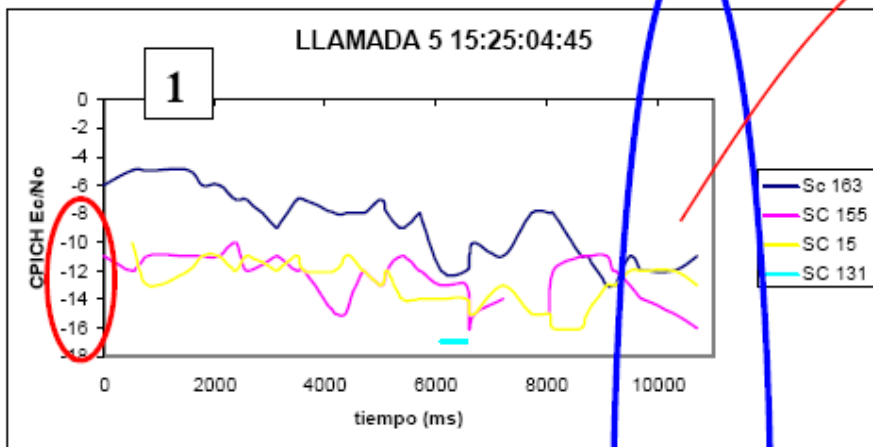

Se comprueba como al no tener un buen nivel de CPICH Ec/No, (en servidor por debajo de -11dB), y tener un valor de vecinas de GSM buenas (en servidor -104dBm en RSSI), SE PRODUCE UN EVENTO 3a, salto de tecnología

Evento 3a

Medidas internas UE

```

    [0] :
    UE-InternalEventParam : event6a
    event6a
    timeToTrigger : tt320
    transmittedPowerThreshold : 21
    [1] :
    UE-InternalEventParam : event6b
    event6b
    timeToTrigger : ttt1280
    transmittedPowerThreshold : 18
    measurementReportingMode
    measurementReportTransferMode :
    acknowledgedModeRLC
    periodicalOrEventTrigger : eventTrigger
  
```



Reporting event 6A	Reporting event 6B	Reporting event 6B	Reporting event 6A	Time
--------------------	--------------------	--------------------	--------------------	------

Evento 1d

Cambio de la mejor célula

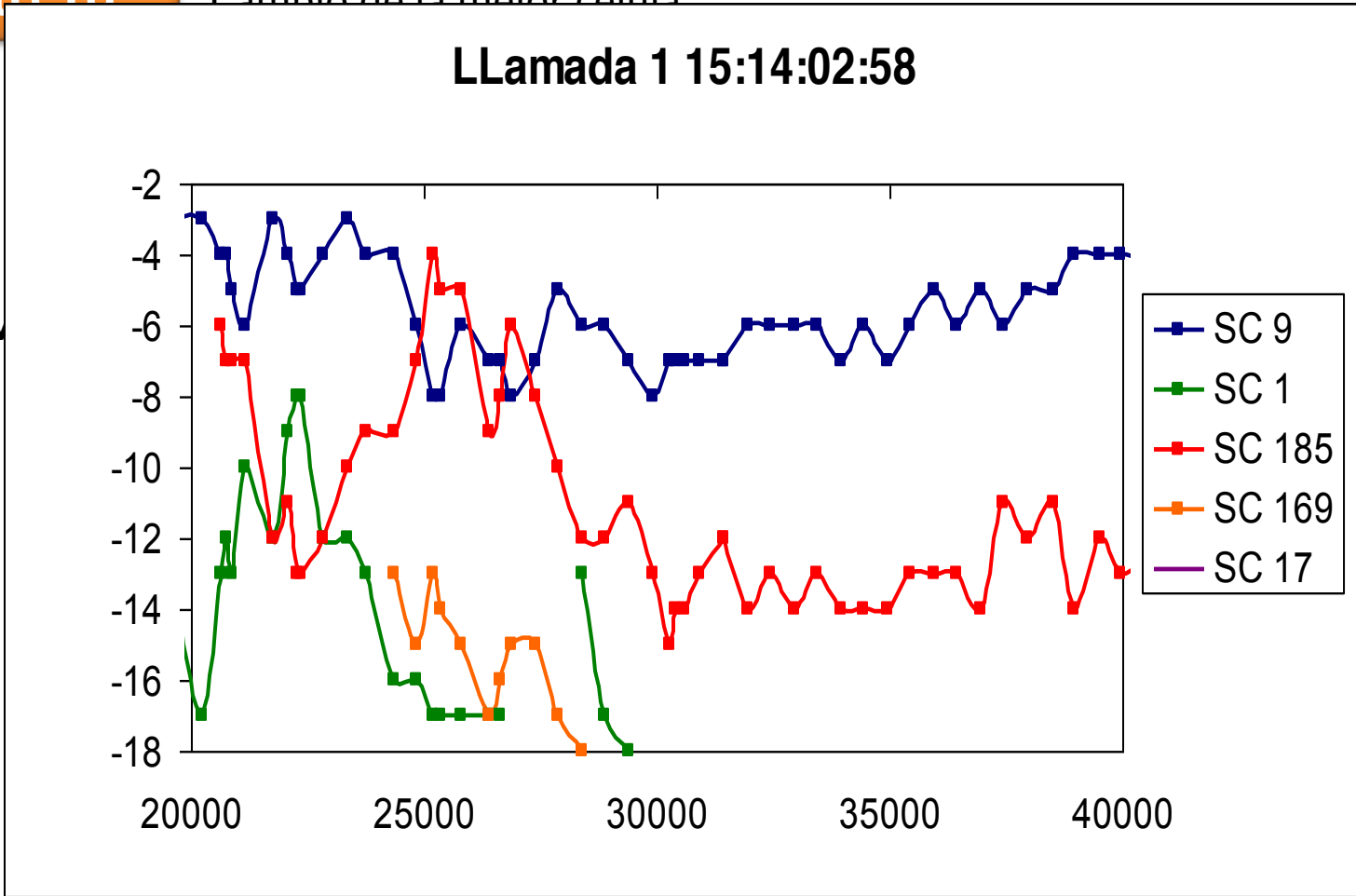

periodicalOrEventTrigger : eventTrigger

iene

Informes periódicos en medidas intra-frecuencia

Fallo al añadir una célula

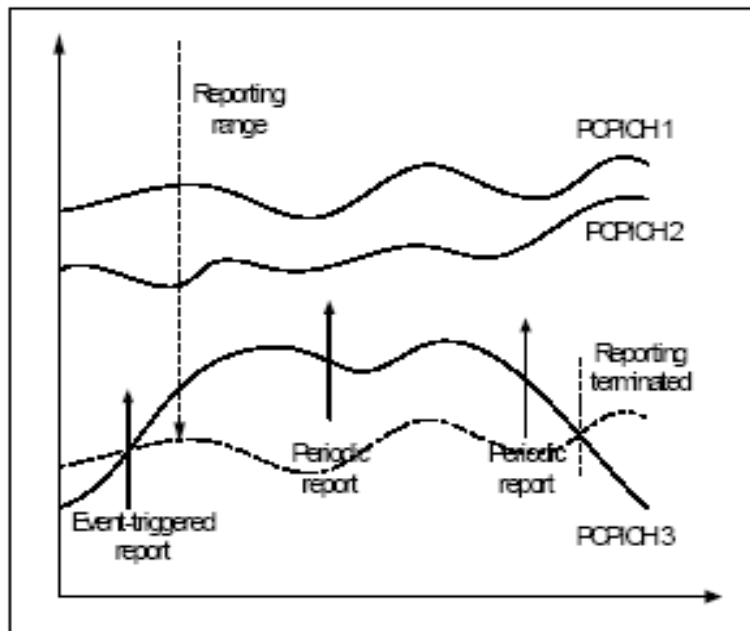

```

event
  IntraFreqEvent : e1a
  e1a
  triggeringCondition
  :detectedSetAndMonitoredSetCells
  reportingRange : 6
  w : 0
  reportDeactivationThreshold : t2
  reportingAmount : ra-Infinity
  reportingInterval : ri1
    
```

- La repetición del envío del informe de medidas debe finalizar si:
- No hay ninguna célula que cumpla ya los criterios del evento1a
 - UTRAN ha añadido un núm. máximo de células (**reporting deactivation threshold**)
 - El UE ha enviado el número máximo de mensajes MEASUREMENT REPORT (**amount of reporting**)

Informes periódicos en medidas intra-frecuencia Fallo al reemplazar una célula

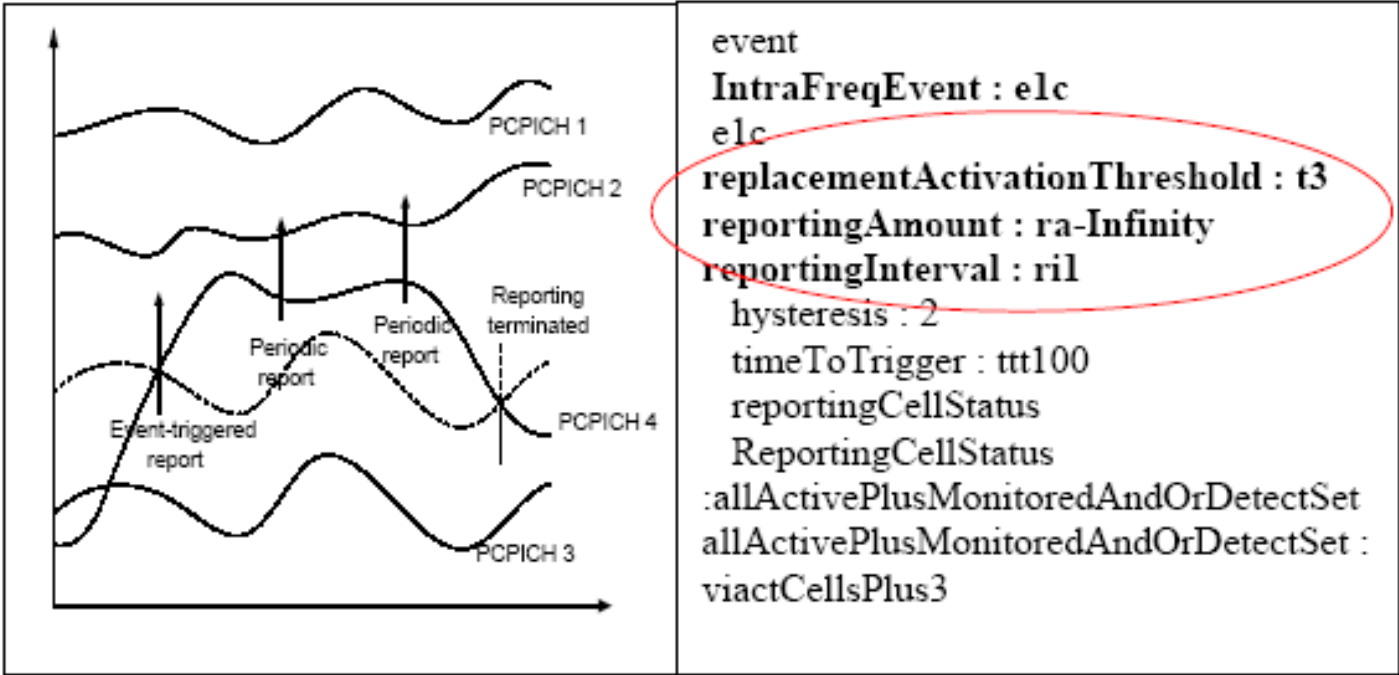

La repetición sucesiva del envío de informes deberá ser parado si:

- no existe ninguna célula que cumpla las condiciones de triggering del evento1c;
- UTRAN ha eliminado células del active set (**replacement activation threshold**); o
- el UE ha enviado el número máximo de mensajes MEASUREMENT REPORT (definido por el parámetro **amount of reporting**).

Mecanismos disponibles para una modificación en las medidas intra-frecuencia

Histéresis

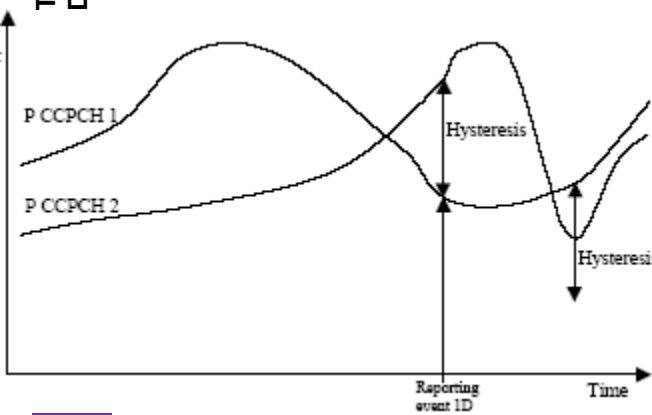

El valor de la histéresis asegura que no se informa del evento 1d (Primary_CPICH 2 llega a tener mejor nivel que 1) hasta que la diferencia sea igual al propio valor de histéresis.

Time To Trigger

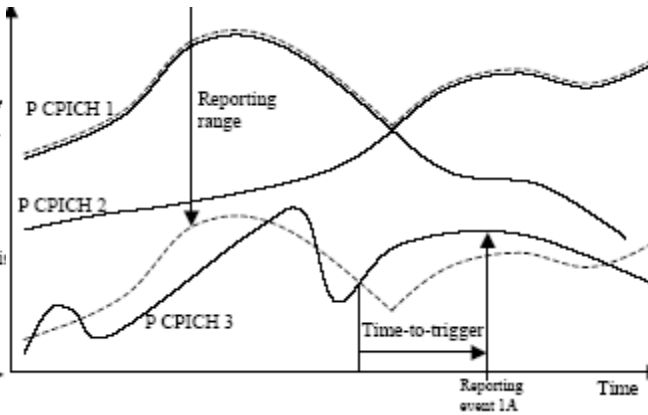

El efecto del time to trigger es el de exigir la permanencia de las condiciones de triggering durante un periodo de tiempo regulable a nivel de RNC para que un evento se produzca

Cell Individual Offset

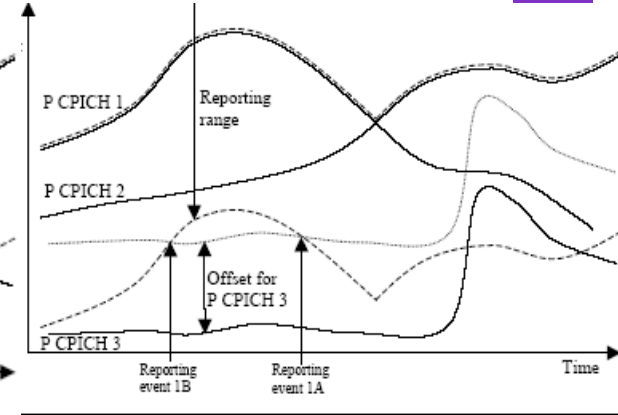

La técnica del offset puede resultar muy interesante si el operador conoce el comportamiento de una célula específica. Nivel de célula

M

Ev

S

Tipo
 AS
 AS
 MN

LLAMADA 3

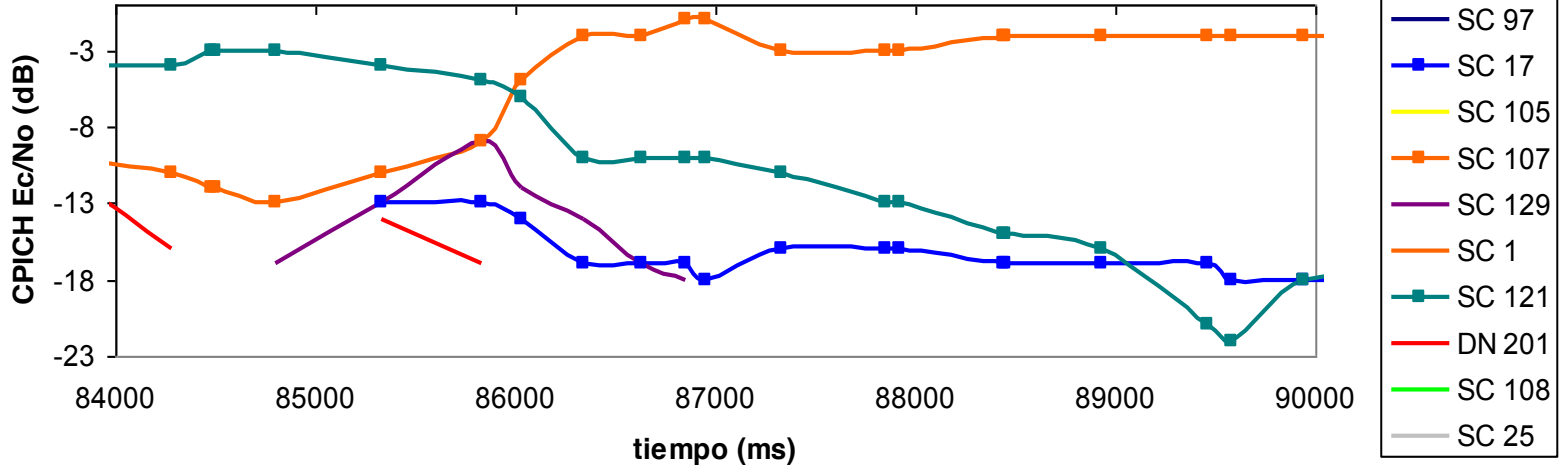

ndo
 uto

eventos acumulativos

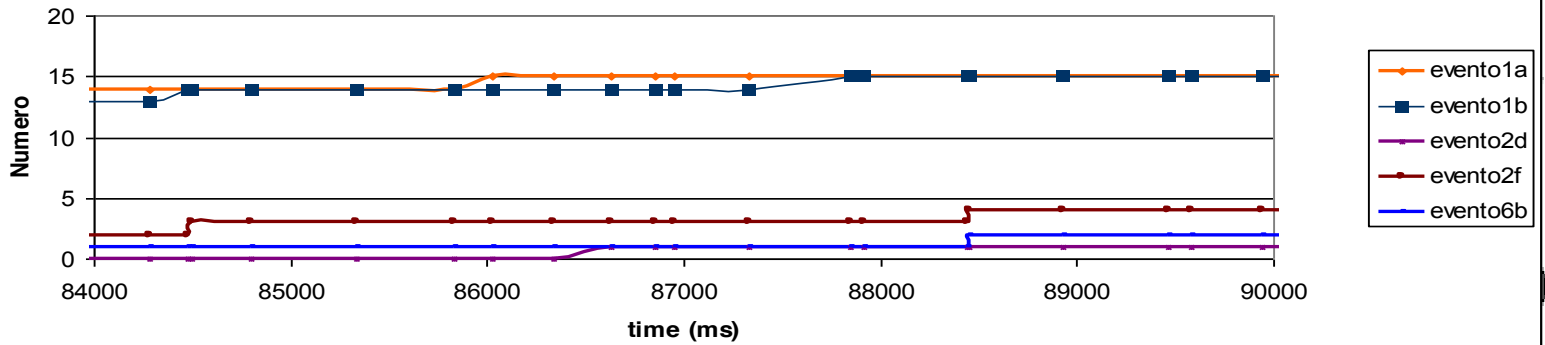

2f

Measurement Control (DL-DCCH)

Time: 15:25:14.27

Protocol Version nr : 2.0

Report Id : (0) RRC Message Report

Timestamp : 16379284

Logical Channel : (0) DCCH

Direction : (1) Downlink

rrc-MessageSequenceNumber : 3

MeasurementControl : r3

measurementControl-r3

rrc-TransactionIdentifier : 3

measurementIdentity : 3

measurementCommand

MeasurementCommand : modify

measurementType

MeasurementType :

interRATMeasurement

interRATMeasurement

interRATCellInfoList

removedInterRATCellList

RemovedInterRATCellList :

removeNoInterRATCells

newInterRATCellList

NewInterRATCellList :

[0] :

interRATCellID : 11

technologySpecificInfo : gsm

interRATCellIndividualOffset : 0

bsic

ncc : 1

bcc : 7

frequency-band : dcs1800BandUsed

bcch-ARFCN : 30

reportCriteria

InterRATReportCriteria

interRATReportingCriteria

interRATReportingCriteria

interRATEventList

InterRATEventList :

[0] :

InterRATEvent : event3a

event3a

thresholdOwnSystem : -11

w : 0

thresholdOtherSystem : -102

hysteresis : 0

timeToTrigger : ttt100

reportingCellStatus

ReportingCellStatus

withinActSetOrVirtualActSet-InterRATcells

withinActSetOrVirtualActSet-

InterRATcells :

OMA
na
enos

Medidas inter RAT (Radio Access Technology)

Evento 3a

*Quando la calidad estimada de una frecuencia en uso en una red WCDMA está por debajo de un umbral absoluto y el RSSI de una portadora de una célula GSM/GPRS está por encima de un umbral absoluto durante al menos un tiempo igual al timeToTrigger, se dice que se ha producido un **evento3a**.*

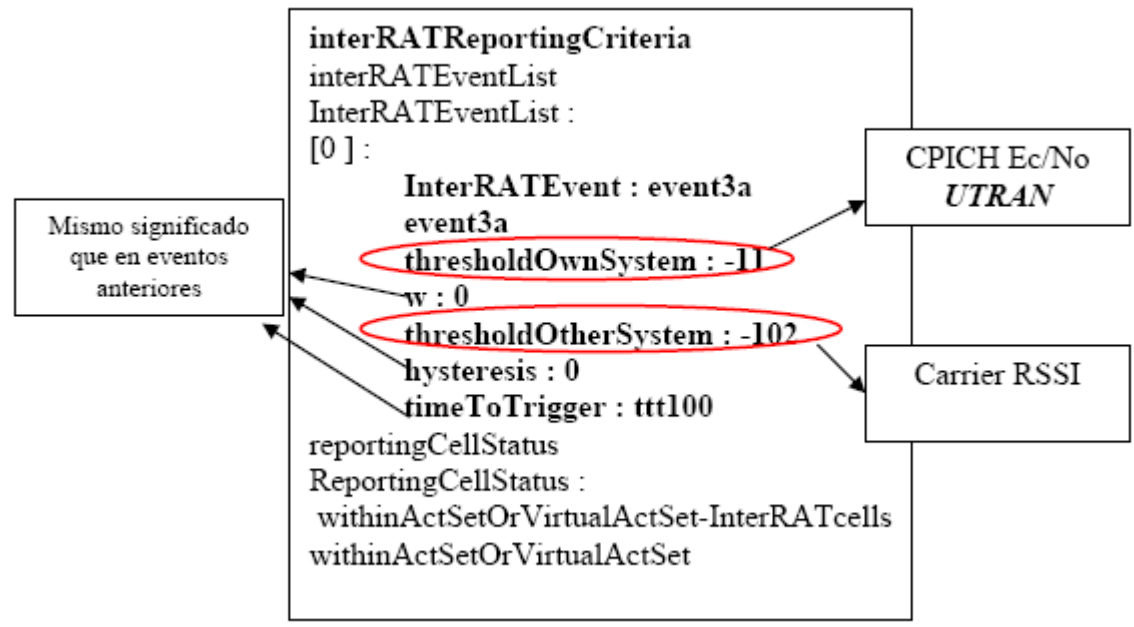

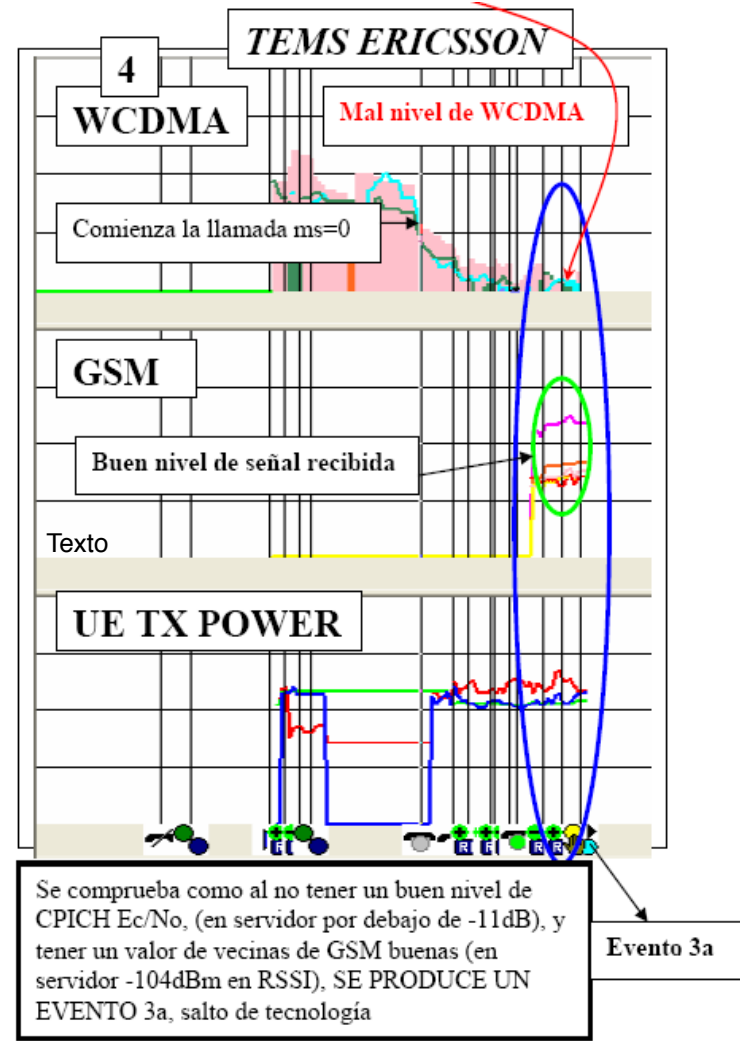
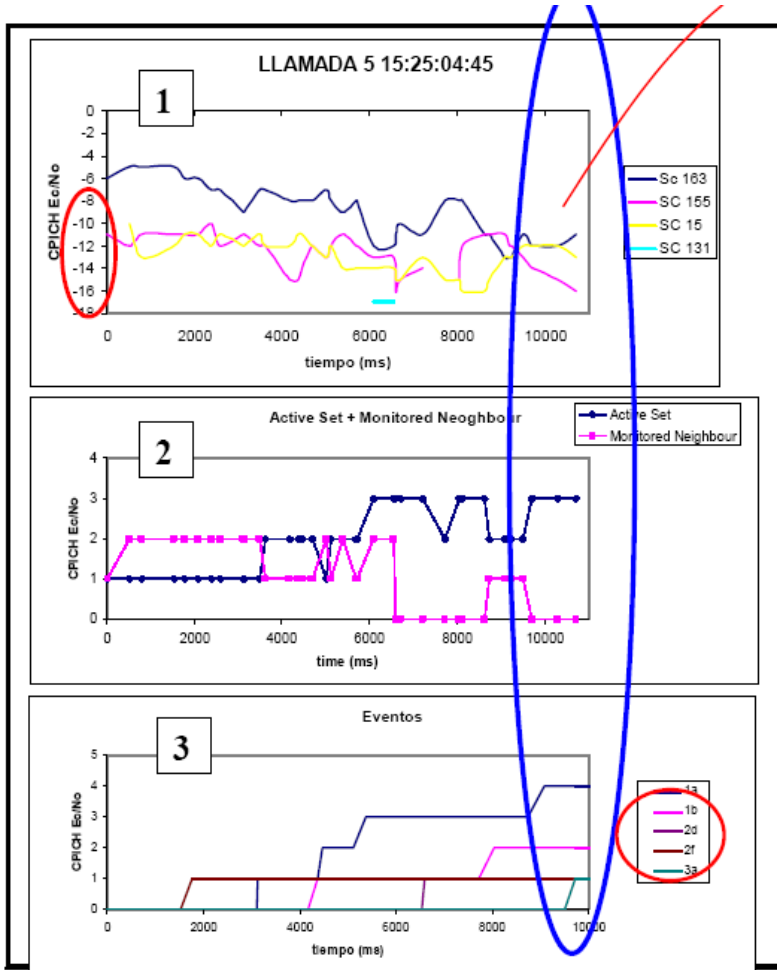

Comunicaciones Móviles

Sistemas de Traceo

Area de Ingeniería Telemática
<http://www.tlm.unavarra.es>

Area de Teoría de la Señal y Comunicaciones
<http://csm.unavarra.es>

Tecnologías Avanzadas de Red
Grado en Ingeniería de Telecomunicación, 3º