

upna

Universidad Pública de Navarra  
Nafarroako Unibertsitate Publikoa

Redes de Nueva Generación  
*Área de Ingeniería Telemática*

# 802: Cambios físicos recientes

# IEEE 802

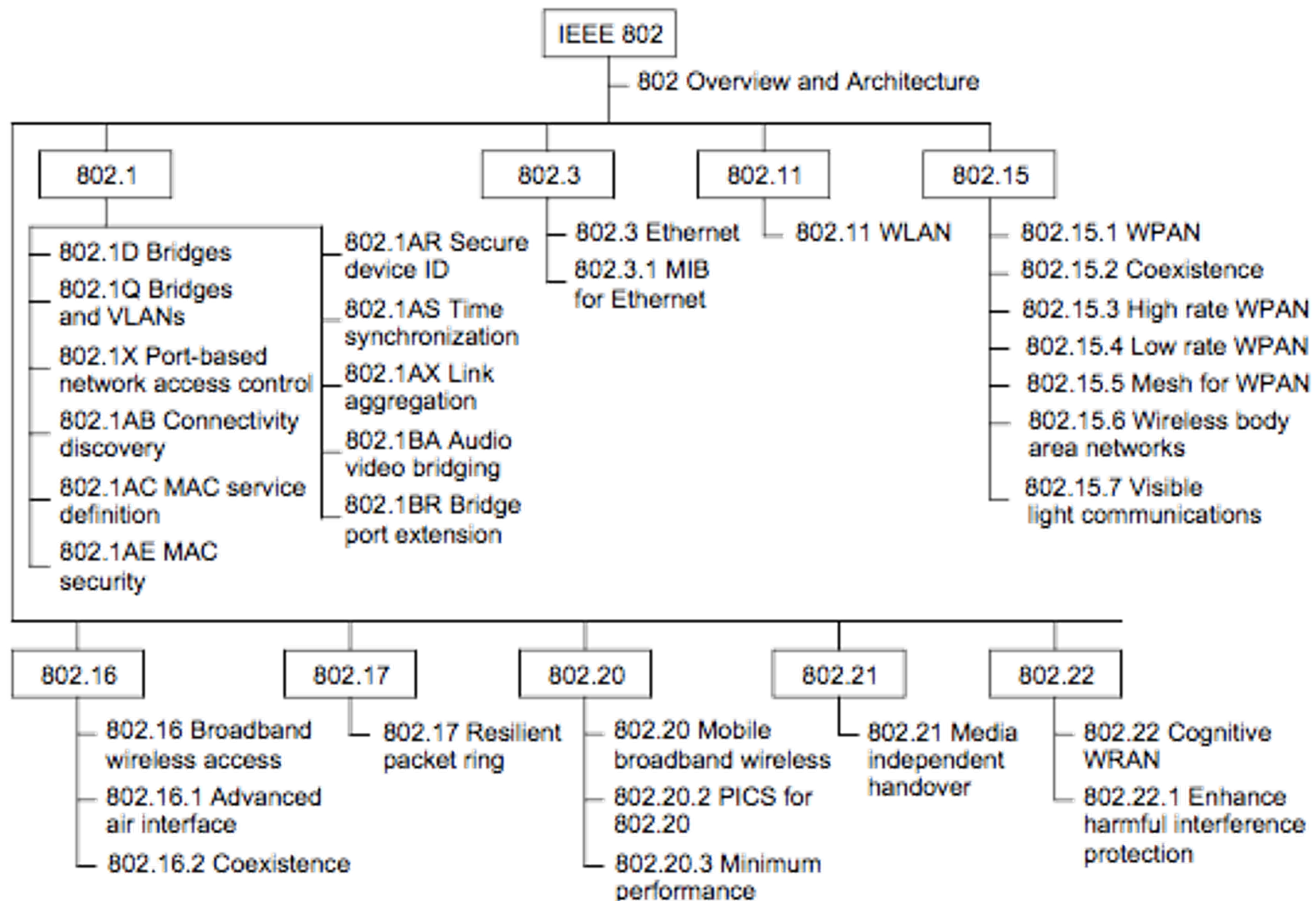

Figure 1—Current family of IEEE 802 standards and recommended practices

upna

Universidad Pública de Navarra  
Nafarroako Unibertsitate Publikoa

**Redes de Nueva Generación**  
*Área de Ingeniería Telemática*



# 802.3



# Tecnologías Ethernet

100Base-X

1000Base-X

10GBase-X

40GBase-X

100GBase-X

200GBase-X

400GBase-X

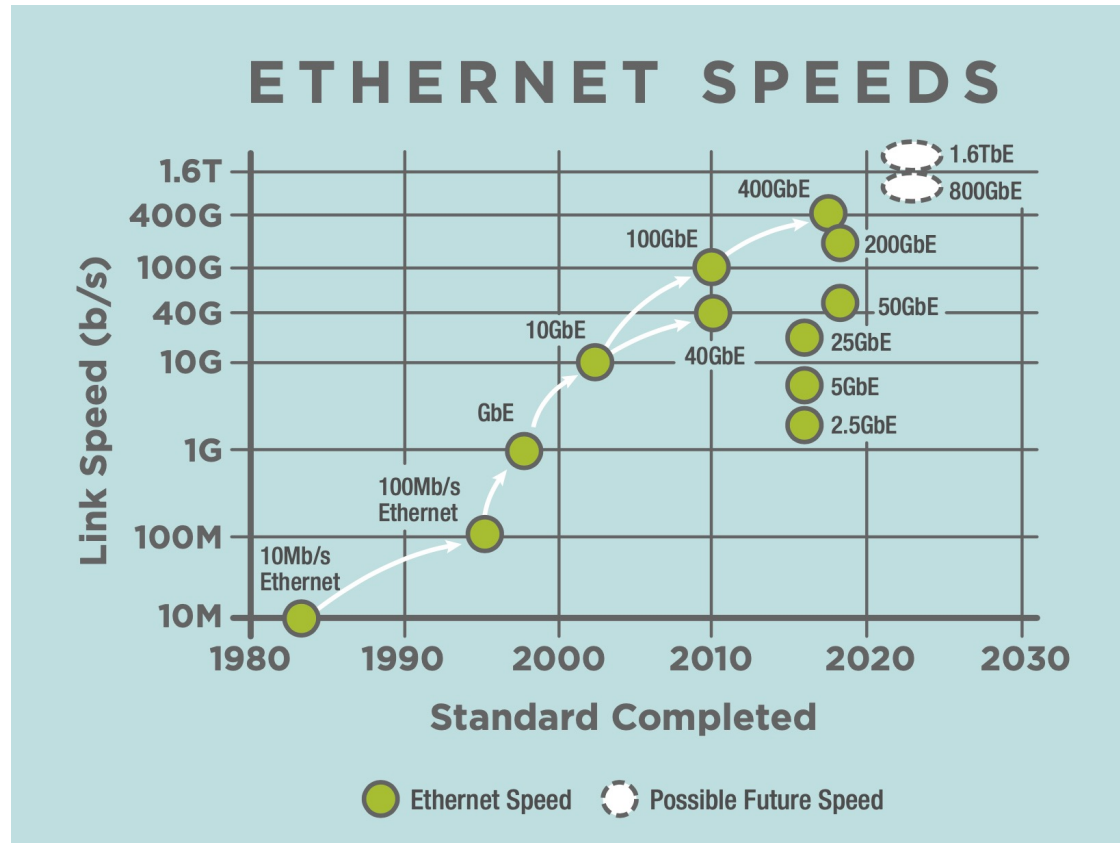

# Nuevas versiones

- **802.3bz (2016)**
  - 2.5GBase-T y 5GBase-T
  - Empleando cat. 5e y 6 (gran planta instalada)
  - Útil para salidas de Access Points
    - 802.11n: 600Mbps
    - 802.11ac (wave 1, wave 2): 3.47 – 6.93 Gbps
    - Hace falta el 75% de la tasa inalámbrica en el cableado
- **802.3cb-2018**
  - 2.5Gb/s y 5Gb/s en backplane

Cable	1 Gbps	2.5 Gbps	5 Gbps	10 Gbps
Category 5e	✓	✓	✓	Not Supported
Category 6	✓	✓	✓	✓ (55m)
Category 6a	✓	✓	✓	✓



# Nuevas versiones



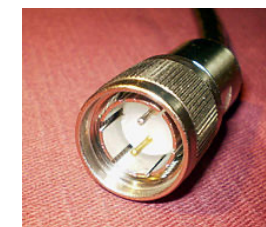









- **25GBase-CR, 25GBase-SR**
  - Sobre twinaxial cable (5m) o fibra multimodo (802.3by-2016)
  - Más eficiente que 40G (40G es 4x10G, 25G es 1 lane)
  - Mejor utilización de capacidad de conmutación de ASICs (2015 ya a 3.2Tbps)
- **25GBase-LR, 25GBase-ER**
  - 802.3cc-2017
  - 10 ó 40Km sobre fibra óptica monomodo



Physical Layer Reach	1 m Backplane	3 m Copper Cable	5 m Copper Cable	30 m Twisted-Pair	70 m OM3 / 100 m OM4
Name	25GBASE-KR	25GBASE-CR-S	25GBASE-CR	25GBASE-T	25GBASE-SR
Standard	September 2016 IEEE 802.3by	September 2016 IEEE 802.3by	September 2016 IEEE 802.3by	March 2016 IEEE 802.3bq	September 2016 IEEE 802.3by
Electrical Signaling (Gb/s)	1 x 25	1 x 25	1 x 25	1 x 25	1 x 25
Media Signaling (Gb/s)	1 x 25	1 x 25	1 x 25	1 x 25	1 x 25
Media Type	Backplane	Twinax Copper	Twinax Copper	Cat 8	Duplex MMF
Module Type	Backplane	SFP28	SFP28	RJ45	SFP28

# Nuevas versiones

- **25GBase-T, 40GBase-T**
  - 30 metros sobre par trenzado categoría 8 (802.3bq-2016)
- **25GBase-BR10, 25GBase-BR20, 25GBase-BR40**
  - Single strand single-mode fiber (10Km, 20Km, 40Km)
  - 802.3cp-2021

	Data Center Server and Access 40 GE to 4 x 10 GE Breakout			Aggregation and Core Native 40 GE		
Physical Layer Reach	10 m Passive Copper Cable	100 m OM3/OM4	7 m Passive Copper Cable	100 m OM3/150 m OM4	10 km SMF	40 km SMF
Pluggable Module	 10GSFP+Cu	 10GBASE-SR	 40GBASE-CR4	 40GBASE-SR4	 40GBASE-LR4	 40GBASE-ER4
Media	 Integrated Twinax (QSFP+ to 4 x SFP+)	 Parallel MMF (MPO to 4 x Duplex LC)	 Integrated Twinax (QSFP+ to QSFP+)	 Parallel MMF (12-Fiber MPO)	 Duplex SMF (LC)	 Duplex SMF (LC)
Standard	July 2009 SFF-8431	June 2002 IEEE 802.3ae	June 2010 IEEE 802.3ba	June 2010 IEEE 802.3ba	June 2010 IEEE 802.3ba	February 2015 IEEE 802.3bm

# Nuevas versiones

- **50GBase-BR10, 50GBase-BR20, 50GBase-BR40**
  - Single strand single-mode fiber (10Km, 20Km, 40Km)
  - 802.3cp-2021
- **50GBASE-CR, 50GBASE-FR, 50GBASE-KR,  
50GBASE-LR, 50GBASE-SR**
  - 802.3cd-2018



# 100G

- Primera generación eran 10x10Gbps
- Segunda generación 4x25Gbps (menor tamaño y consumo)
- Se está reduciendo el tamaño de los módulos
- Eso permite mayor densidad de puertos

## FORM FACTORS

This diagram shows the most common form factors used in Ethernet ports. Hundreds of millions of RJ45 ports are sold a year while tens of millions of SFP and millions of QSFP ports ship a year.

1-4 Lane Interfaces

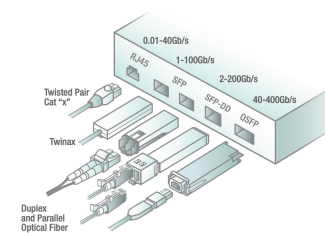

This diagram shows new form factors initially designed for 100GbE and 400GbE Ethernet ports.

4+ Lane Interfaces

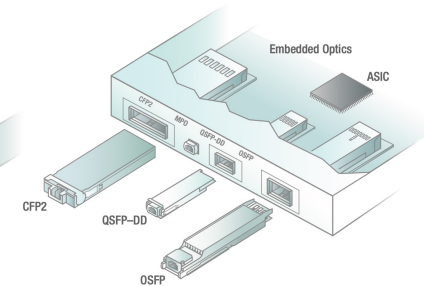

Physical Layer Reach	1 m Backplane	5 m Copper Cable	7 m Copper Cable	70 m OM3 / 100 m OM4	100 m OM3 / 150 m OM4	2 km SMF	10 km SMF	40 km SMF		
Name	100GBASE-KP4 100GBASE-KR4	100GBASE-CR4	100GBASE-CR10	100GBASE-SR4	100GBASE-SR10	10x10-2km	10x10-10km	100GBASE-LR4	10x10-40km	100GBASE-ER4*
Standard	June 2014 IEEE 802.3bj	June 2014 IEEE 802.3bj	June 2010 IEEE 802.3ba	February 2015 IEEE 802.3bm	June 2010 IEEE 802.3ba	March 2011 10x10 MSA	August 2011 10x10 MSA	June 2010 IEEE 802.3ba	August 2011 10x10 MSA	June 2010 IEEE 802.3ba
Electrical Signaling (Gb/s)	4 x 25	4 x 25	10 x 10	4 x 25	10 x 10	10 x 10	10 x 10	10 x 10	10 x 10	10 x 10
Media Signaling (Gb/s)	4 x 25 NRZ and PAM-4	4 x 25	10 x 10	4 x 25 850 nm	10 x 10 850 nm	10 x 10 1310 nm λs	10 x 10 1310 nm λs	4 x 25 1550 nm λs	10 x 10 1310 nm λs	4 x 25 1550 nm λs
Media Type	Backplane	Twinax Copper	Twinax Copper	Parallel MMF (12-Fiber MPO)	Parallel MMF (24-Fiber MPO)	Duplex SMF	Duplex SMF	Duplex SMF	Duplex SMF	Duplex SMF
Module Type	Backplane	CFP2, CFP4, QSFP28	CXP, CFP2, CFP4, QSFP28	CFP2, CFP4, CPAK, QSFP28	CFP, CFP2, CFP4, CPAK, CXP	CFP	CFP	CFP, CFP2, CFP4, CPAK, QSFP28	CFP	CFP, CFP2
Market Availability	2014+	2014+	2010	2015+	2012	2011	2011	2010	TBD	2012

# > 100 Gb/s

- **802.3cd-2018**

- 50Gb/s, 100Gb/s y 200Gb/s Ethernet
- Sobre twinaxial, fibra o backplane
- 50GBASE-CR, 50GBASE-FR, 50GBASE-KR, 50GBASE-LR, 50GBASE-SR, 100GBASE-DR, 100GBASE-KR2, 100GBASE-SR2, 200GBASE-CR4, 200GBASE-KR4, 200GBASE-SR4

- **802.3cu-2021**

- 100GBase-FR1, 100GBase-LR1, 400GBase-FR4, 400GBase-LR4-6
- 10Km, SMF (100Gb/s per wavelength)

# 400 Gb/s

- **802.3bs-2017**
  - 200Gb/s y 400Gb/s
  - 400GBase-SR8, 400GBase-DR4, 400GBase-XDR4, 400GBase-FR4, etc
- **802.3cm-2020**
  - 400GBASE-SR4.2 y 400GBASE-SR8
  - 2 pares y 8 pares de fibra multimodo respectivamente, 100m
- **802.3cn-2019**
  - 50 Gb/s, 200 Gb/s y 400 Gb/s sobre fibra monomodo

Physical Layer Reach	100 m MMF	500 m SMF	2 km SMF	10 km SMF
25 Gb/s NRZ	16 $\lambda$ x 16 MMF			
50 Gb/s NRZ		2 $\lambda$ x 4 SMF	8 $\lambda$ x 1 SMF	8 $\lambda$ x 1 SMF
50 Gb/s PAM-4			8 $\lambda$ x 1 SMF	8 $\lambda$ x 1 SMF
100 Gb/s PAM-4		1 $\lambda$ x 4 SMF	4 $\lambda$ x 1 SMF	
100 Gb/s DMT				4 $\lambda$ x 1 SMF

# 802.3br-2016

- “Specification and Management Parameters for Interspersing Express Traffic”
- Latencia para iniciar la transmisión de un paquete *express* debe ser  $< 2$  veces el tiempo del paquete mínimo + IPG
- Añade soporte para tráfico preemptivo
- *eMAC* = *express MAC*
- *pMAC* = *preemptable MAC*

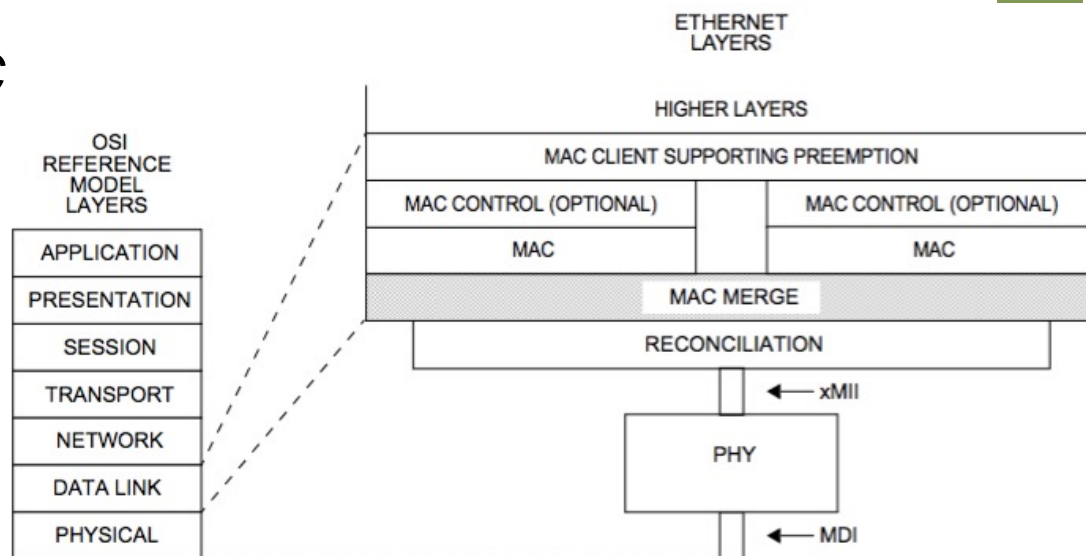

NOTE—In this figure, the xMII is used as a generic term for the Media Independent Interfaces for implementations of 100 Mb/s and above. For example: for 100 Mb/s implementations this interface is called MII; for 1 Gb/s implementations it is called GMII; for 10 Gb/s implementations it is called XGMII; etc.

MAC = MEDIA ACCESS CONTROL  
xMII = MEDIA INDEPENDENT INTERFACE

MDI = MEDIUM DEPENDENT INTERFACE  
PHY = PHYSICAL LAYER DEVICE

**Figure 99-1—Relationship of MAC Merge sublayer to the ISO/IEC Open Systems Interconnection (OSI) reference model and the IEEE 802.3 Ethernet model**

# Otras

- **802.3bw-2015**
  - 100Base-T1 Ethernet sobre un solo par trenzado balanceado (15m)
- **802.3bp-2016**
  - 1000Base-T1 Ethernet sobre un solo par trenzado (15m)
- **802.3cg-2019**
  - 10Base-T1L (1Km), 10Base-T1S (15m), single balanced pair of conductors
- **802.3ch-2020**
  - 2.5GBase-T1, 5GBase-T1 y 10GBase-T1 sobre par balanceado (Automotive Electrical Ethernet) (15m)



Length of automotive wiring system can exceed 3 km with up to 1,500 cables and up to 3,000 contacts.

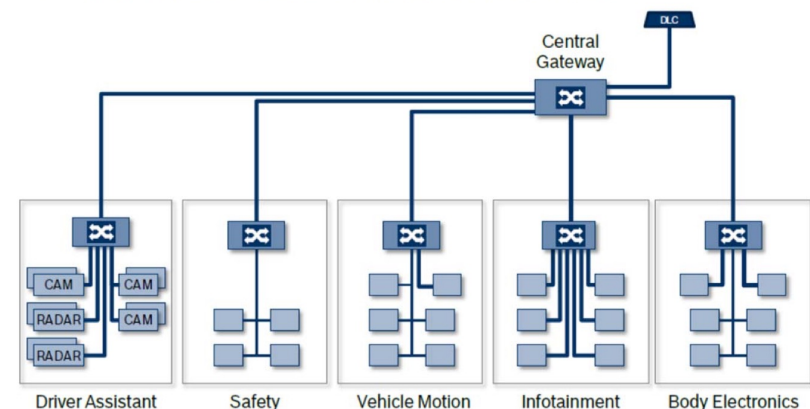

# Otras

- **802.3bn-2016**
  - 10GPass-XR
  - EPON sobre coaxial
- **802.3ca-2020**
  - EPON compatible con 10Gb/s EPON
  - 25/10 Gb/s, 25/25 Gb/s, 50/10 Gb/s, 50/25 Gb/s y 50/50 Gb/s
  - 20 km, Split ratio 1:32

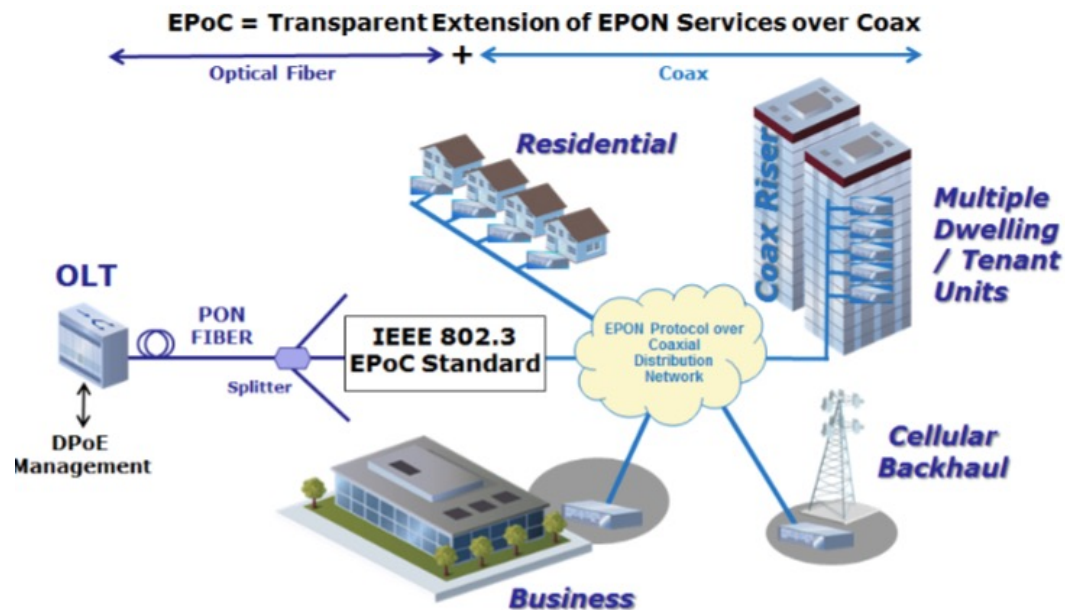

# Resumen

## ETHERNET SPEEDS

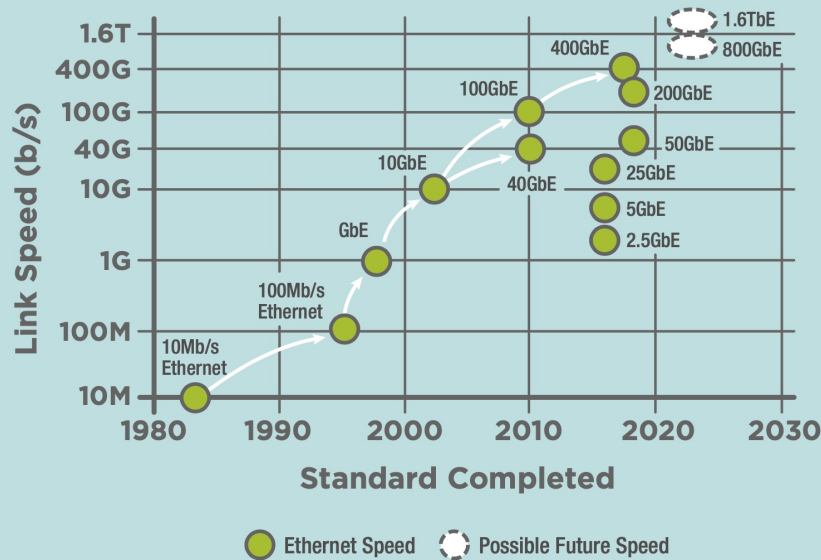

## FATTER PIPES

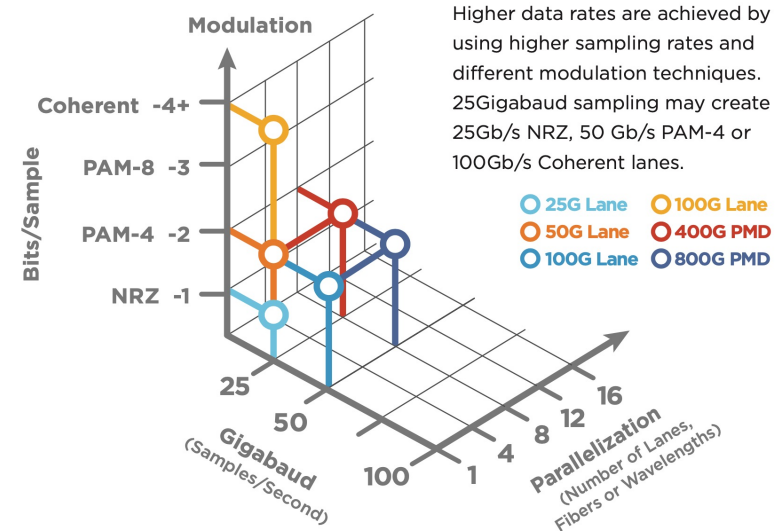

## PATH TO SINGLE LANE

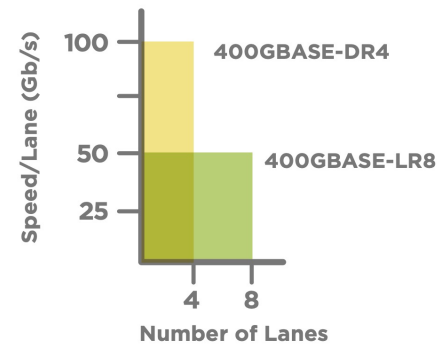
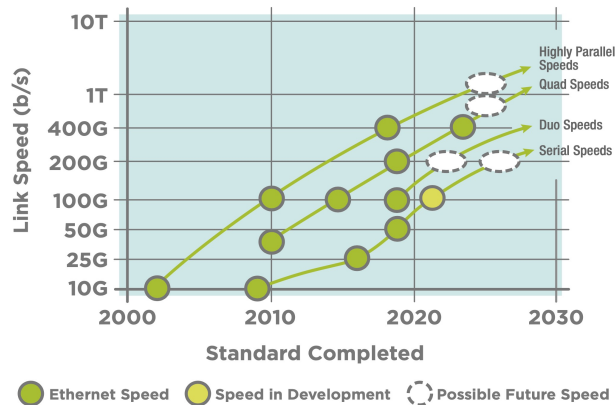

After the data rate/lane is chosen, the number of lanes in a link determines the speed. This chart shows how 4 or 8 lanes can be used to generate 400GbE links.

# Resumen

## LATEST INTERFACES AND NOMENCLATURE

	Backplane	Twinax Cable	Twisted Pair (1 Pair)	Twisted Pair (4 Pair)	MMF	500m PSM4	2km SMF	10km SMF	20km SMF	40km SMF	80km SMF	Electrical Interface
10BASE-	T1S		T1S/T1L									
100BASE-			T1									
1000BASE-			T1	T								
2.5GBASE-	KX		T1	T								
5GBASE-	KR		T1	T								
10GBASE-			T1	T				BIDI Access	BIDI Access	BIDI Access		
25GBASE-	KR	CR/CR-S		T	SR			LR/ EPON/ BIDI Access	EPON/ BIDI Access	ER/ BIDI Access		25GAUI
40GBASE-	KR4	CR4		T	SR4/eSR4	PSM4	FR	LR4				XLAUI XLPPi
50GBASE-	KR	CR			SR		FR	EPON/ BIDI Access LxR	EPON/ BIDI Access	BIDI Access ER		LAUI-2/50GAUI-2 50GAUI-1
100GBASE-	KR4 KR2 KR1	CR10 CR4 CR2 CR1			SR10 SR4 SR2 SR1	PSM4 DR	10X10-2km CWDm4/ FR1 100G-FR	10X10-10km LR4/ 4WDM-10 LR1 100G-LR	4WDM-20	ER4/ 4WDM-40	ZR	CAUI-10 CPPI CAUI-4/100GAUI-4 100GAUI-2 100GAUI-1
200GBASE-	KR4 KR2	CR4 CR2			SR4 SR2	DR4	FR4	LR4		ER4		200GAUI-4 200GAUI-2
400GBASE-	KR4	CR4			SR16 SR8/SR4.2 SR4	DR4	FR8 FR4 400G-FR4	LR8 LR4-6 400G-LR4-10		ER8	ZR	400GAUI-16 400GAUI-8 400GAUI-4

Gray Text = IEEE Standard    Red Text = In Standardization    Green Text = In Study Group  
Blue Text = Non-IEEE standard but complies to IEEE electrical interfaces



# Resumen

**AUTOMOTIVE** Ethernet is one of Ethernet's latest success stories. Forecasts predict up to 500 million ports of Ethernet will ship in over 100M vehicles by 2021. Ethernet links within cars provide data and power to reduce the cost and weight in vehicles while providing economies of scale and interoperability. The bandwidth demand of connected cars could be the next big driver for Ethernet to go beyond 400GbE!

**ENTERPRISE** and Campus applications drive the bulk of Ethernet port shipments with hundreds of millions of ports shipping per year. Ethernet's roots are in enterprise local area networks (LANs) where the entire Ethernet family, including the BASE-T products, can be found. LANs are rich in copper where over 70 Billion meters of cable have been deployed over the past 15 years. Enterprise data centers are very cost sensitive and most servers deploy GbE and 10GbE, and are expected to transition to 25GbE.

**SERVICE PROVIDERS** have driven higher speed Ethernet solutions for decades. Router connections, EPON, client side optics for optical transport network (OTN) equipment, and wired and wireless backhaul. In particular, the 5G mobile deployment is driving dramatic increases in both fronthaul and backhaul applications, and continues to push Ethernet to higher rates and longer distances. And with global demand by consumers for video, this shows no signs of changing.

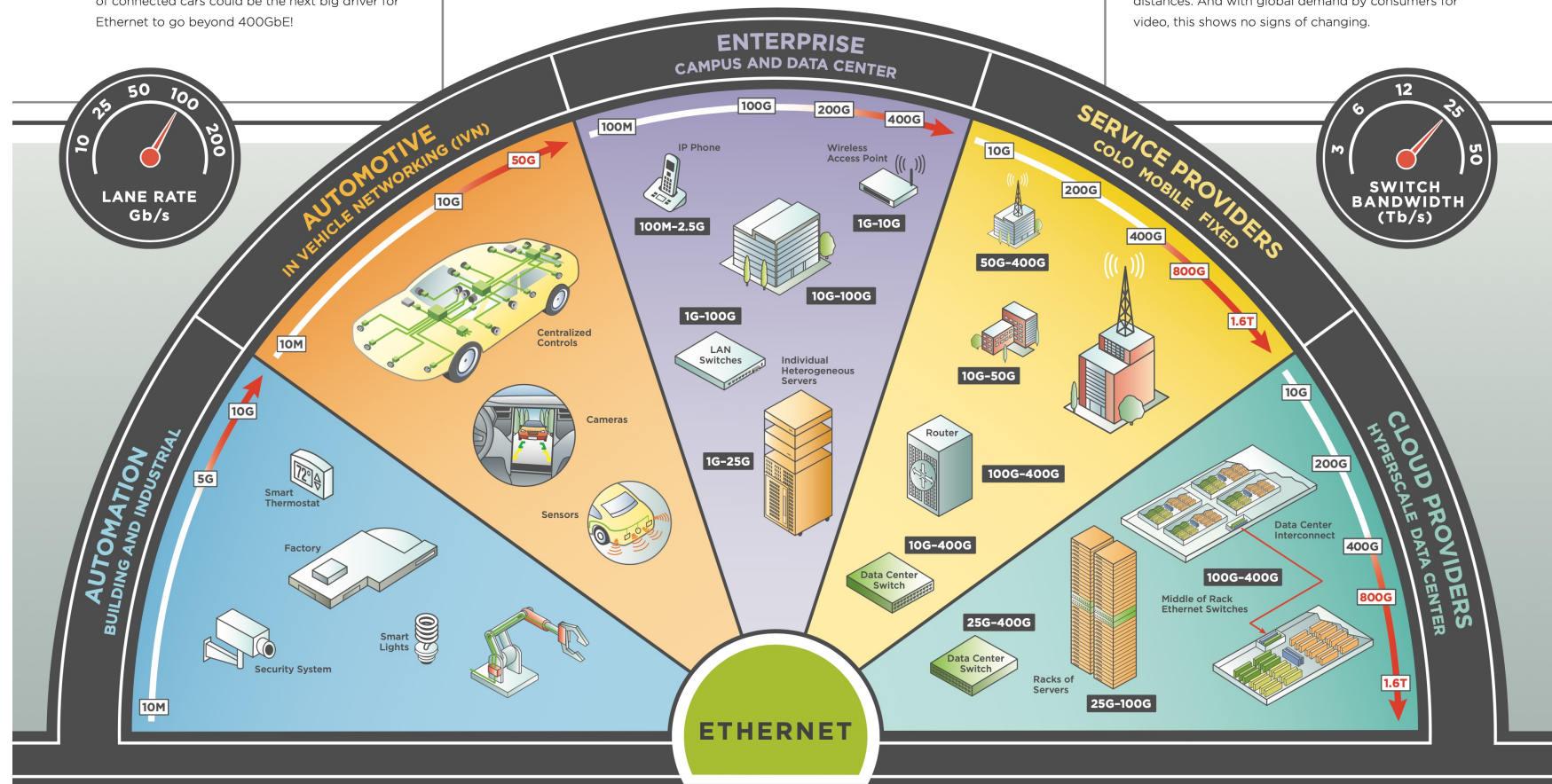

upna

Universidad Pública de Navarra  
Nafarroako Unibertsitate Publikoa

**Redes de Nueva Generación**  
*Área de Ingeniería Telemática*

802.11



# 802.11



## Wi-Fi 4



- 802.11n (ya 802.11-2020)
- Tanto en 2.4 GHz como 5 GHz
- Compatible con 802.11a/b/g
- Canales de 20MHz o 40 MHz
- MIMO
- Hasta 4 *streams* espaciales
- Streams de 150 Mb/s
- Permite *beamforming*
- Trae mejoras en MAC como la agregación de PDUs

## Wi-Fi 5



- 802.11ac (ya 802.11-2020)
- En 5 GHz
- Canales 20, 40, 80 ó 160 MHz
- Los dispositivos suelen a la vez soportar 802.11n
- *Beamforming*
- Hasta 8 *streams* espaciales
- MU-MIMO (máx. a 4 clientes)

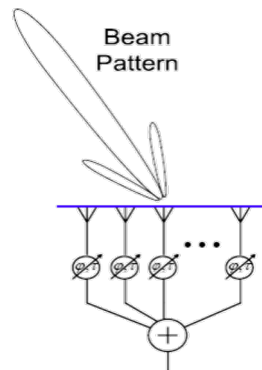
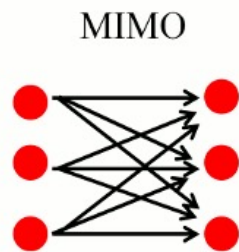
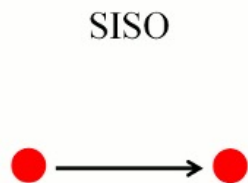

(a) Single-user MIMO

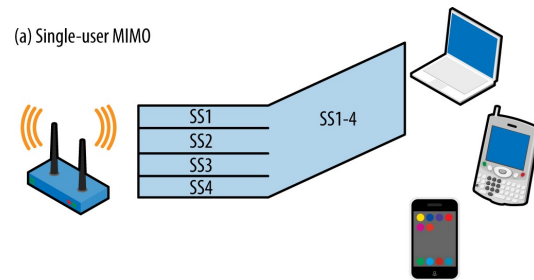

(b) Multi-user MIMO

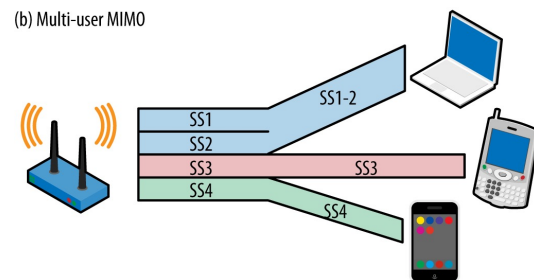

# Waves 802.11ac

## Wave 1

- 1.3 Gbps (PHY rate), 845 Mbps (MAC throughput)
- SU-MIMO
- Canal de 20 MHz, 40 MHz ó 80 MHz
- Aprox. 25, 12 ó 6 canales
- 3 streams espaciales

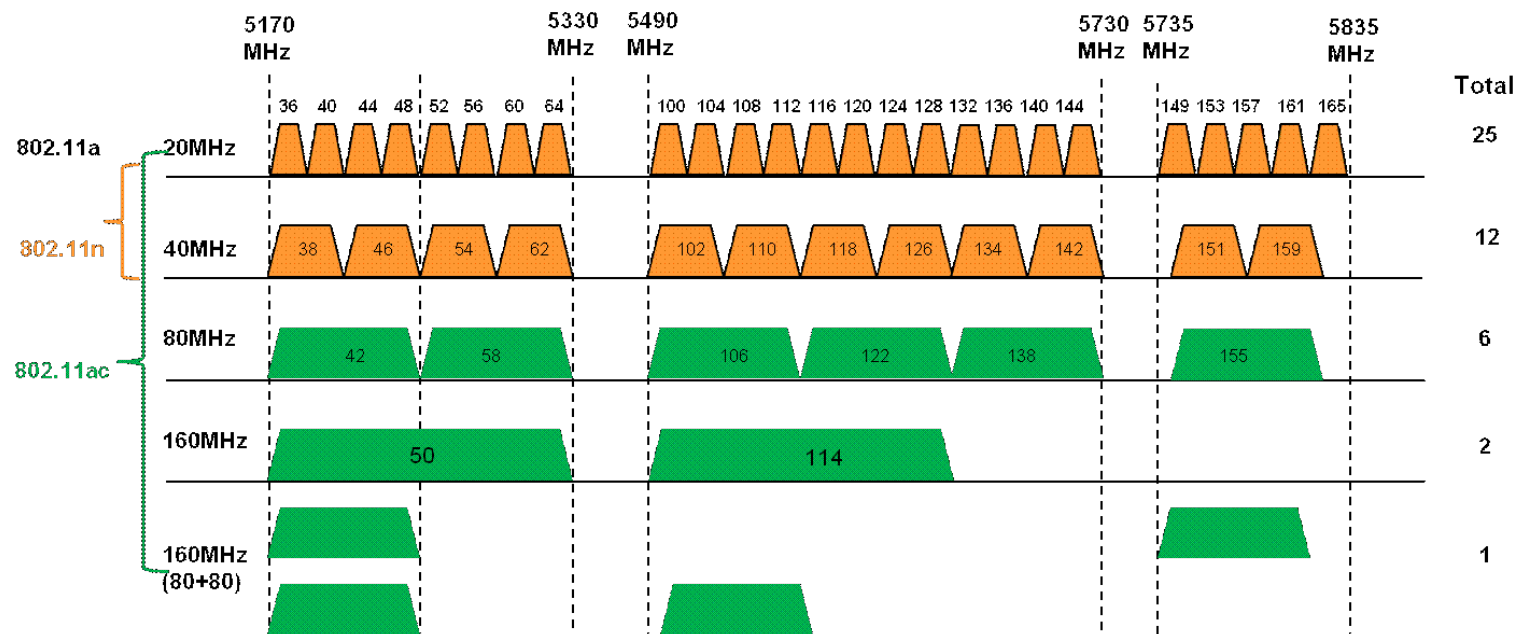

# Waves 802.11ac

## Wave 2

- 3.47 (PHY), 2.26 Gbps (MAC)
  - MU-MIMO (solo downlink)
  - Canal hasta 160 MHz
  - Hasta 4 streams espaciales
- AP 4x4 puede enviar a 4 clientes 1x1 simult.
  - Evita que desaprovechen el tiempo de uso del medio
  - Requiere explicit transmit beamforming

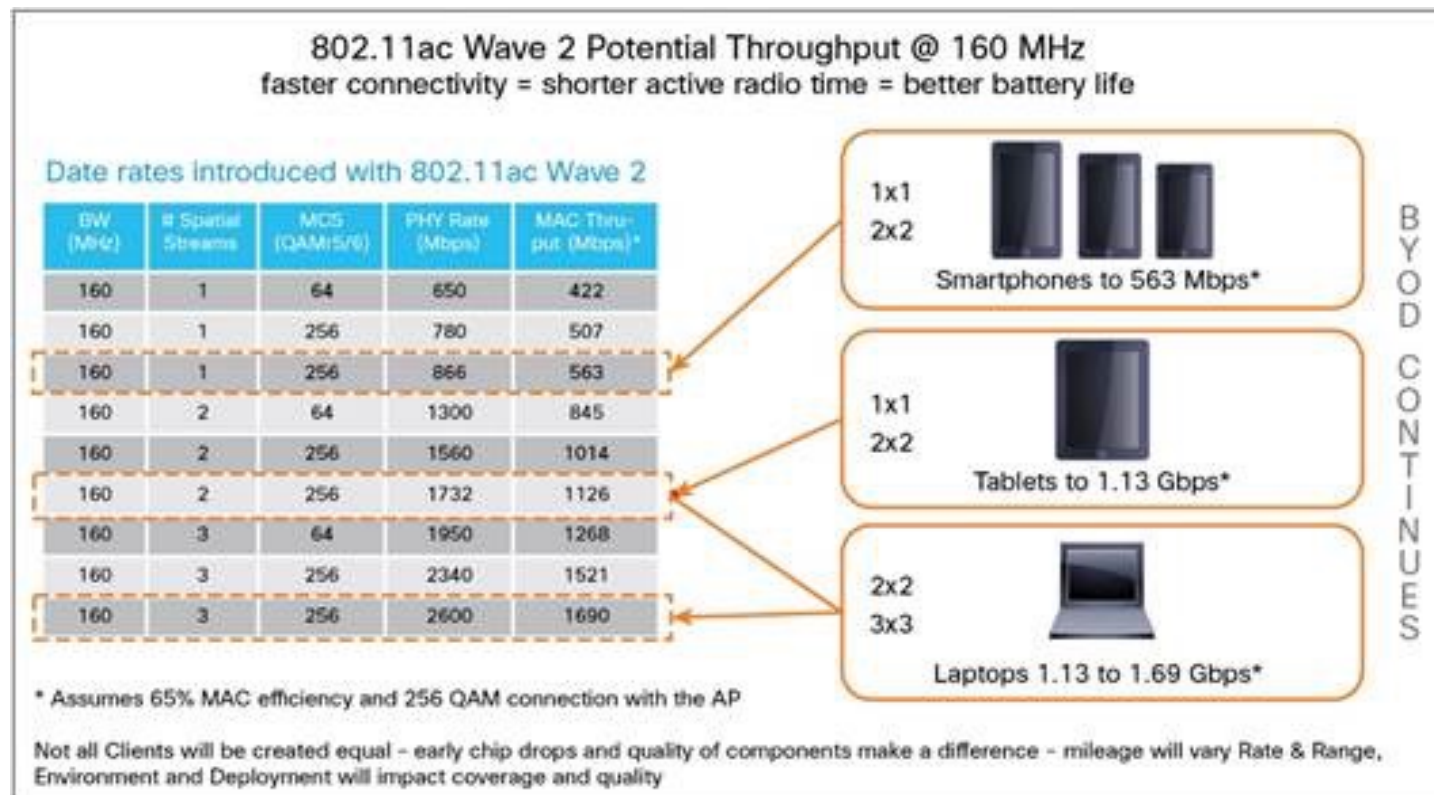

# 802.11ax (Wi-Fi 6)



- Desde mayo de 2021
- Amendment de 767 páginas a 802.11-202 (de 4379 páginas)
- Finales de 2018 primeros equipos pre-estándar
- 2.4 GHz y 5 GHz
- Busca mejora 4x
- Wave 1 puede soportar 8 streams. Beamforming
- Multiuser (OFDMA o MU-MIMO hasta 8 clientes, en wave 2 también en uplink)
- Hasta 1024-QAM



If the most advanced technology a device supports is ...	Then it shall be identified as generation
802.11ax	Wi-Fi 6
802.11ac	Wi-Fi 5
802.11n	Wi-Fi 4

PHY	Bandwidth (as number of data subcarriers)	Data bits per subcarrier	Time per OFDM symbol (800ns GI)	1 SS	3 SS	4 SS	8 SS
802.11ac	234 (80 MHz)	$5/6 \times \log_2(256) \approx 6.67$	4 $\mu$ s	390 Mbps	1.17 Gbps	1.56 Gbps	-
	2 x 234 (160 MHz) X	/	=	780 Mbps	-	3.12 Gbps	-
802.11ax	980 (80 MHz)	$5/6 \times \log_2(1024) \approx 8.33$	13.6 $\mu$ s	600 Mbps	1.8 Gbps	2.4 Gbps	4.8 Gbps
	2 x 980 (160 MHz)			1.2 Gbps	3.6 Gbps	4.8 Gbps	-



Wi-Fi CERTIFIED 6™  
Worldwide Wi-Fi 6E interoperability  
Wi-Fi 6 CERTIFIED

# 802.11ax (Wi-Fi 6E)

- 6 GHz sin licencia (1.2GHz de BW)
- Hasta 7 canales de 160 MHz no interferentes
- MU-MIMO uplink
- Aprox. 2Gb/s con latencia sub-ms hasta 3m, 1.4 Gb/s a 7m
- Nuevo MAC

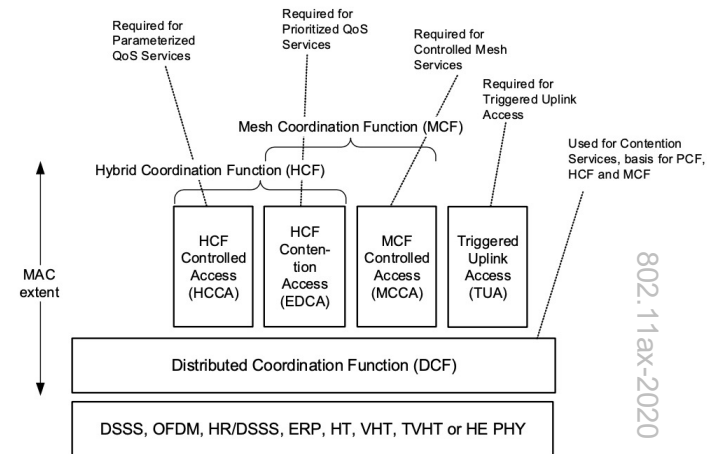
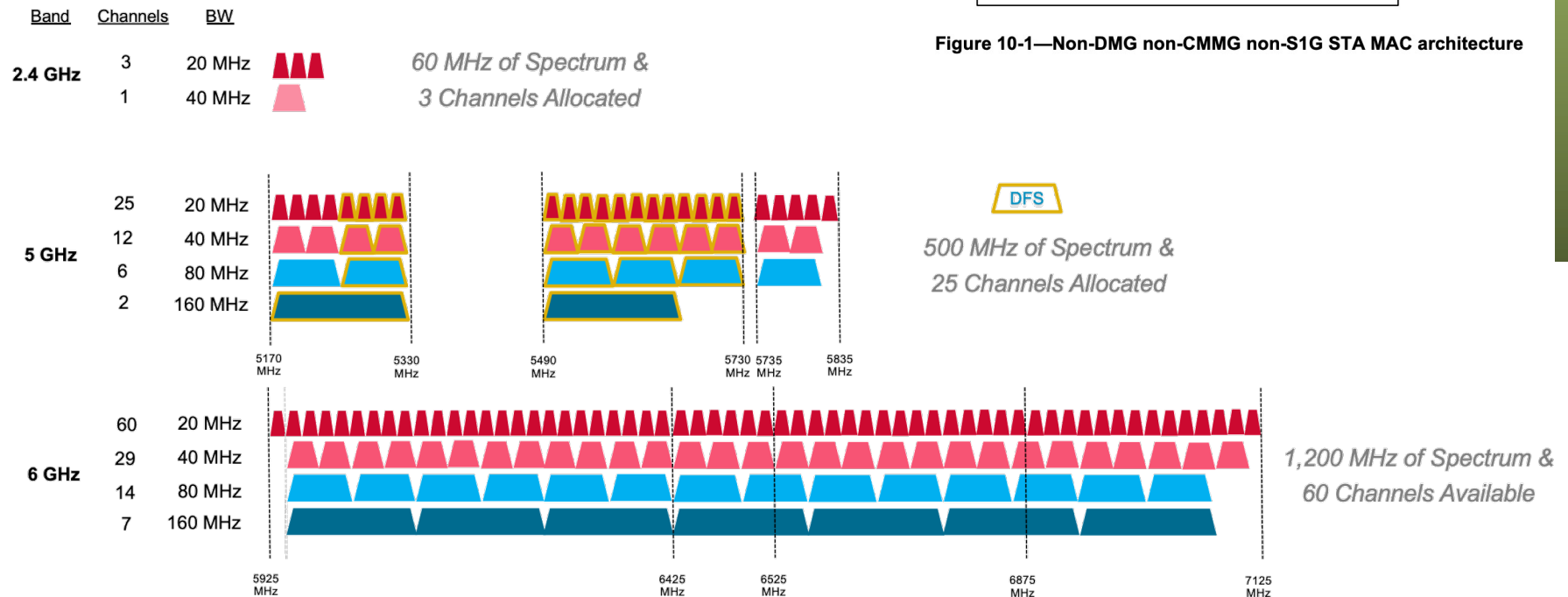

Figure 10-1—Non-DMG non-CMMG non-S1G STA MAC architecture



# Otras

## 802.11ah-2016 (Wi-Fi HaLow)

- “Sub 1GHz License Exempt Operation”, low power
- Alcance de hasta 1km; IoT, industrial
- Canales de 1, 2, 4, 8 y 16 MHz
- Tasa al menos 100Kb/s

## 802.11af-2013

- Banda TV VHF/UHF (54-790MHz según país)

## 802.11ad (WiGig)

- BW 2GHz en banda de 60GHz
- Cerca de 7 Gb/s, corta distancia
- Baja latencia, visión directa

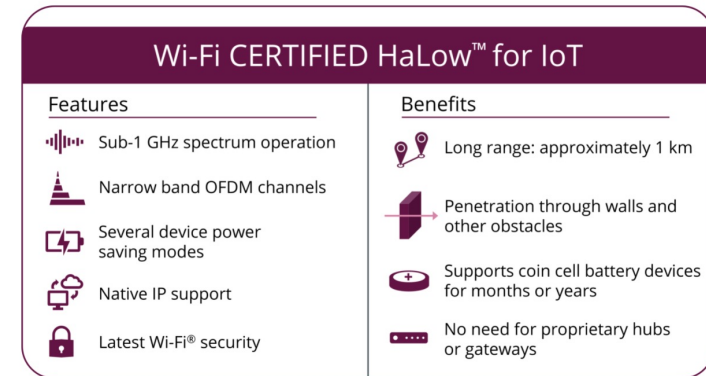
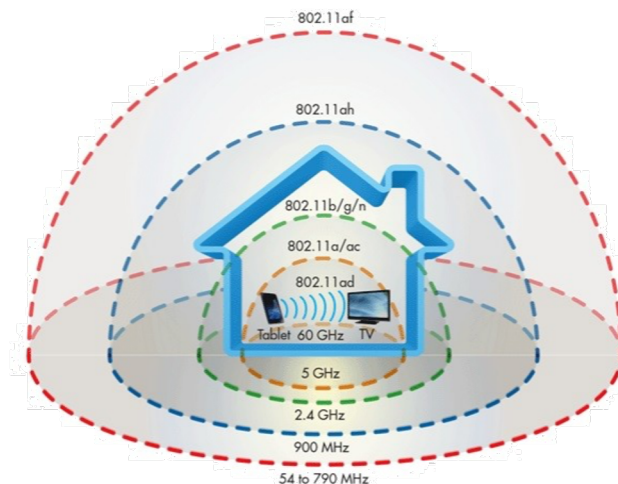

<https://www.wi-fi.org/discover-wi-fi/wi-fi-certified-halow>

