

upna

Universidad Pública de Navarra  
Nafarroako Unibertsitate Publikoa

# Versiones de Ethernet

Area de Ingeniería Telemática

<http://www.tlm.unavarra.es>

Grado en Ingeniería en Tecnologías de  
Telecomunicación, 3º

upna

Universidad Pública de Navarra  
Nafarroako Unibertsitate Publikoa



# Ethernet “everywhere”



# Ethernet hoy en día

- Comienzos tasa de transmisión de 2.94 Mbps
- Primera versión comercial a 10Mb/s (coaxial)
- Hoy en día se vende a 10Gb/s, 40Gb/s y 100Gb/s y sigue subiendo...
- Sobre par trenzado (de distintos tipos) y fibra óptica principalmente

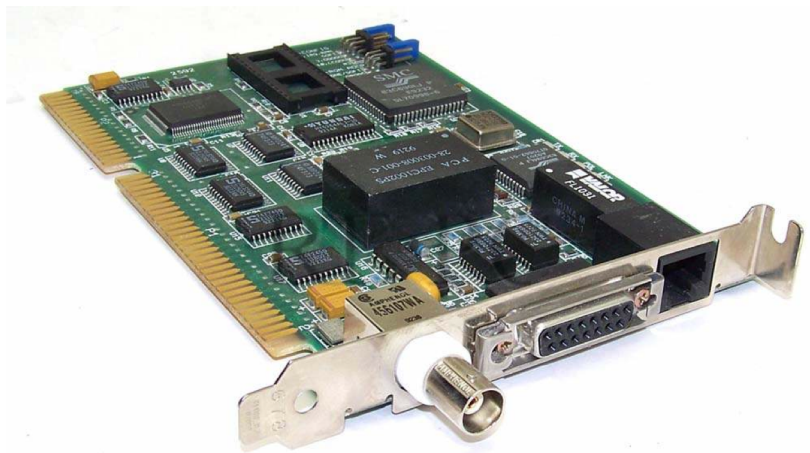

NIC Ethernet a 10Mbps  
Conectores AUI, BNC y RJ-45



Transceiver 100GBASE-LR4  
100Gbps Eth a 10Km sobre f.o. monomodo

# Ethernet hoy en día

- Surgió para LAN y ya se emplea en WAN
- Y ofrece servicios para operadoras y para el acceso (primera milla)

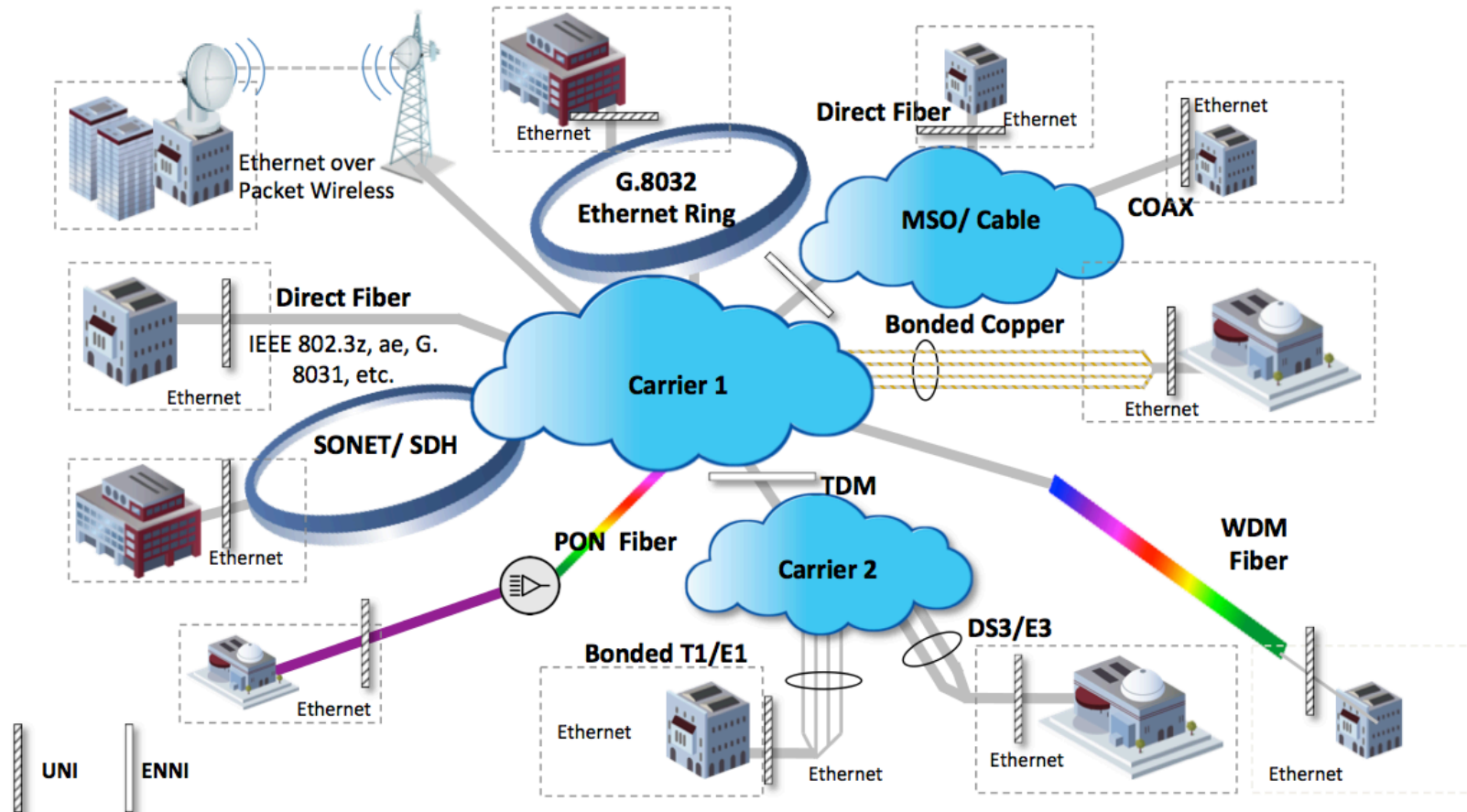



# Ethernet hoy en día

- Nació para LAN coaxial, aunque basada en ALOHA, y ha vuelto a inalámbrico (WiFi)



# Ethernet hoy en día

- Empezó para PCs e impresoras y ahora se emplea en WANs pero también en microcontroladores en coches, aviones, hogares, industria...

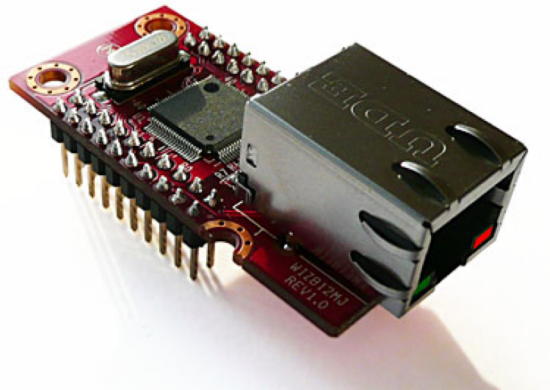

upna

Universidad Pública de Navarra  
Nafarroako Unibertsitate Publikoa

# Nivel MAC Ethernet original

# Nivel MAC

- PDU del nivel de enlace = Trama (*Frame*)
- Formato de la trama (estándar DIX)
  - Direcciones MAC
  - *Ethertype*
  - Datos
  - CRC
- Hoy en día recogido también en el IEEE 802.3

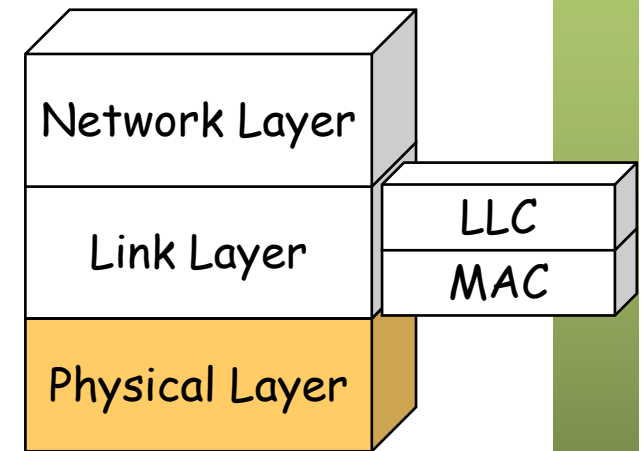

# Trama DIX

No.	Time	Source	Destination	Total L	Source Port	Request Method	Status Code	Info
5	1628304369...	0.0.0.0	255.255.255.2...	313				DHCP Discover - Trans

```

> Frame 5: 327 bytes on wire (2616 bits), 327 bytes captured (2616 bits)
v Ethernet II, Src: PcsCompu_bb:01:05 (08:00:27:bb:01:05), Dst: Broadcast (ff:ff:ff:ff:ff:ff)
  > Destination: Broadcast (ff:ff:ff:ff:ff:ff)
  > Source: PcsCompu_bb:01:05 (08:00:27:bb:01:05)
  Type: IPv4 (0x0800)
  > Internet Protocol Version 4, Src: 0.0.0.0, Dst: 255.255.255.255
  > User Datagram Protocol, Src Port: 68, Dst Port: 67
  > Dynamic Host Configuration Protocol (Discover)
  
```

0000	ff ff ff ff ff ff 08 00	27 bb 01 05 08 00	45 00	.....E.
0010	01 39 00 00 00 00 40 11	79 b5 00 00 00 00 ff ff		.9...@. y.....
0020	ff ff 00 44 00 43 01 25	b4 02 01 01 06 00 d3 59		...D.C.%.....Y
0030	62 22 0d 81 00 00 00 00	00 00 00 00 00 00 00 00		b".....
0040	00 00 00 00 00 00 08 00	27 bb 01 05 00 00 00 00		.....!
0050	00 00 00 00 00 00 00 00	00 00 00 00 00 00 00 00		.....
0060	00 00 00 00 00 00 00 00	00 00 00 00 00 00 00 00		.....
0070	00 00 00 00 00 00 00 00	00 00 00 00 00 00 00 00		.....
0080	00 00 00 00 00 00 00 00	00 00 00 00 00 00 00 00		.....
0090	00 00 00 00 00 00 00 00	00 00 00 00 00 00 00 00		.....
00a0	00 00 00 00 00 00 00 00	00 00 00 00 00 00 00 00		.....
00b0	00 00 00 00 00 00 00 00	00 00 00 00 00 00 00 00		.....
00c0	00 00 00 00 00 00 00 00	00 00 00 00 00 00 00 00		.....
00d0	00 00 00 00 00 00 00 00	00 00 00 00 00 00 00 00		.....
00e0	00 00 00 00 00 00 00 00	00 00 00 00 00 00 00 00		.....
00f0	00 00 00 00 00 00 00 00	00 00 00 00 00 00 00 00		.....
0100	00 00 00 00 00 00 00 00	00 00 00 00 00 00 00 00		.....
0110	00 00 00 00 00 00 63 82	53 63 35 01 01 3d 07 01		.....c. Sc5...=..
0120	08 00 27 bb 01 05 39 02	02 40 37 07 01 03 06 0c		..!...9. @7.....
0130	0f 1c 2a 3c 0c 75 64 68	63 70 20 31 2e 32 30 2e		..*<.udh cp 1.20.
0140	32 0c 03 62 6f 78 ff			2. .box.

Ethernet (eth), 14 bytes      Packets: 9 · Displayed: 1 (11.1%)      Profile: Default



# Trama IEEE

- IEEE 802.3 + 802.2 (LLC/SNAP)
- Campo de **Longitud** (hace referencia a todo lo que le sigue, sin contar el CRC)
- Los *Ethertype* son > 1500 por lo que ambos formatos son compatibles (en realidad  $\geq 1536$ )
- IP sobre 802 en RFC 1042

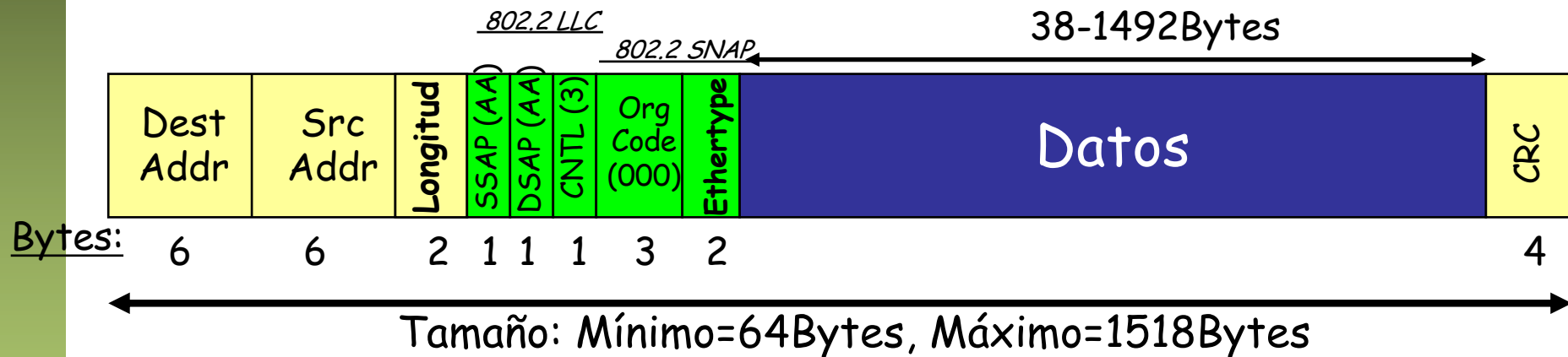
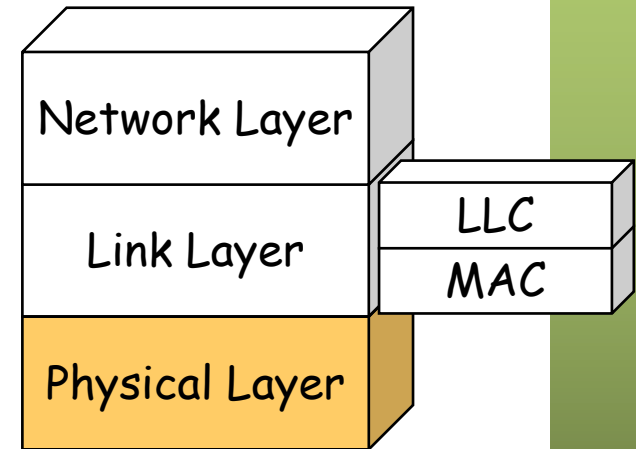

DIX (Ethernet II)



# LLC/SNAP

No.	Time	Source	Destination	Total L	Source Port	Request Method	Status Code	Info
1	1164034146...	Cisco_d5:d5:...	CDP/VTP/DTP/P...					Device ID: R1 Port :

> Frame 1: 300 bytes on wire (2400 bits), 300 bytes captured (2400 bits)

- IEEE 802.3 Ethernet
  - Destination: CDP/VTP/DTP/PagP/UDLD (01:00:0c:cc:cc:cc)
  - Source: Cisco\_d5:d5:15 (00:e0:1e:d5:d5:15)
  - Length: 286
- Logical-Link Control
  - DSAP: SNAP (0xaa)
  - SSAP: SNAP (0xaa)
  - Control field: U, func=UI (0x03)
  - Organization Code: 00:00:0c (Cisco Systems, Inc)
  - PID: CDP (0x2000)
- Cisco Discovery Protocol

```

0000  01 00 0c cc cc cc 00 e0 1e d5 d5 15 01 1e aa aa  ....
0010  03 00 00 0c 20 00 01 b4 df f0 00 01 00 06 52 31  ....R1
0020  00 02 00 11 00 00 00 01 01 01 cc 00 04 c0 a8 0a  ....
0030  01 00 03 00 0d 45 74 68 65 72 6e 65 74 30 00 04  ....Ethernet
0040  00 08 00 00 00 01 00 05 00 d8 43 69 73 63 6f 20  ....Cisco
0050  49 6e 74 65 72 6e 65 74 77 6f 72 6b 20 4f 70 65  Internet work Ope
0060  72 61 74 69 6e 67 20 53 79 73 74 65 6d 20 53 6f  rating S ystem Ope
0070  66 74 77 61 72 65 20 0a 49 4f 53 20 28 74 6d 29  ftware  IOS (tm)
0080  20 31 36 30 30 20 53 6f 66 74 77 61 72 65 20 28  1600 So ftware (
0090  43 31 36 30 30 2d 4e 59 2d 4c 29 2c 20 56 65 72  C1600-NY -L), Ver
00a0  73 69 6f 6e 20 31 31 2e 32 28 31 32 29 50 2c 20  sion 11. 2(12)P,
00b0  52 45 4c 45 41 53 45 20 53 4f 46 54 57 41 52 45  RELEASE SOFTWARE
00c0  20 28 66 63 31 29 0a 43 6f 70 79 72 69 67 68 74  (fc1)C opyright
00d0  20 28 63 29 20 31 39 38 36 2d 31 39 39 38 20 62  (c) 198 6-1998 b
00e0  79 20 63 69 73 63 6f 20 53 79 73 74 65 6d 73 2c  y cisco Systems,
00f0  20 49 6e 63 2e 0a 43 6f 6d 70 69 6c 65 64 20 54  Inc. Co mpiled T
0100  75 65 20 30 33 2d 4d 61 72 2d 39 38 20 30 36 3a  ue 03-Ma r-98 06:
  
```

Logical-Link Control (llc), 8 bytes      Packets: 1 - Displayed: 1 (100.0%)      Profile: Default



# Versiones de Ethernet (10Mb/s)



# Versiones 10Mb/s

- Coaxial (10Base5 y 10Base2)
- Cable UTP cat.3 ó superior (10Base-T)
- Fibra óptica (MM, 10BaseFL)

# Ethernet "original"

## 10Base5

- "Thick Ethernet"
- Coaxial grueso (amarillo)
- 5 → 500m (entre repetidores)

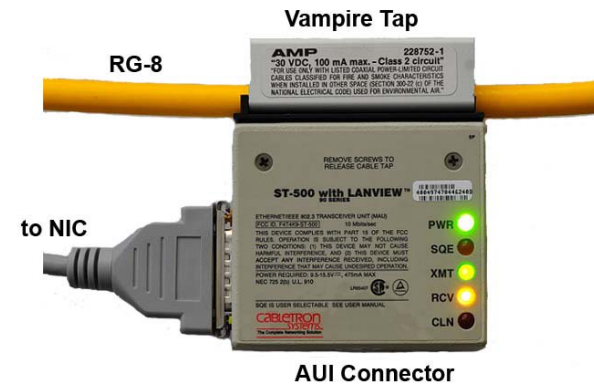

MAU = Medium Attachment Unit  
MDI = Medium Dependent Interface  
AUI = Attachment Unit Interface  
DTE = Data Terminal Equipment

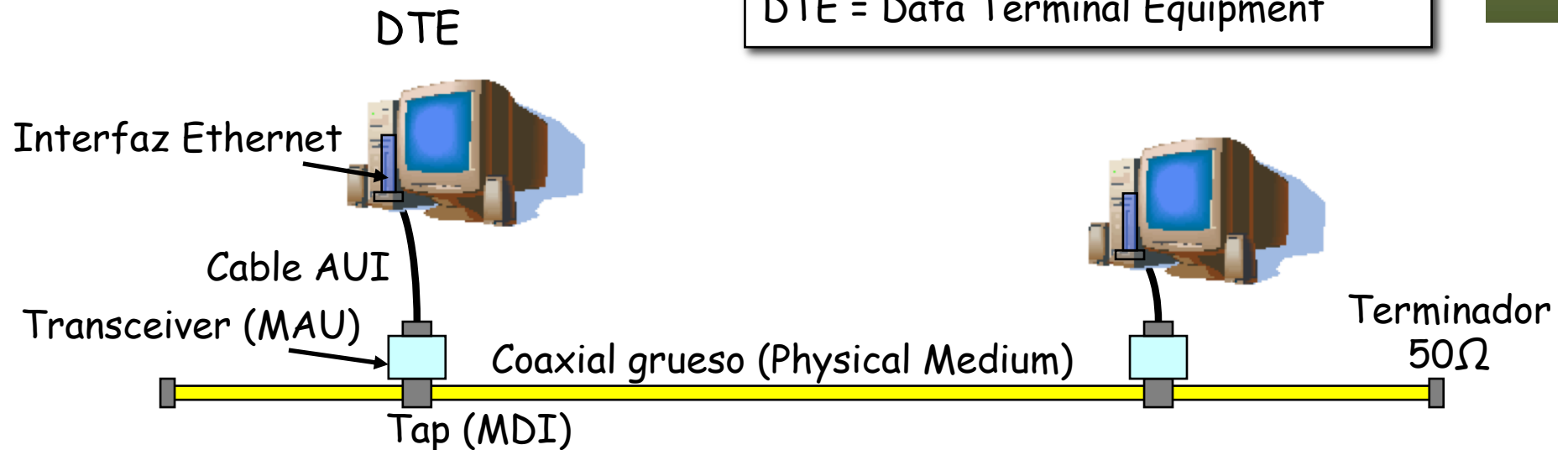

# CSMA/CD

- *Carrier Sense Multiple Access / Collision Detection*
- Máximo 2500 m
- Mínimo 64 Bytes de trama
- Conlleva un tamaño mínimo de la trama de 64 bytes

Tamaño de trama (bytes)	Tiempo de Tx a 10Mbps ( $\mu$ seg)
64	51.2
512	409.6
1000	800
<b>1518</b>	<b>1214.4</b>

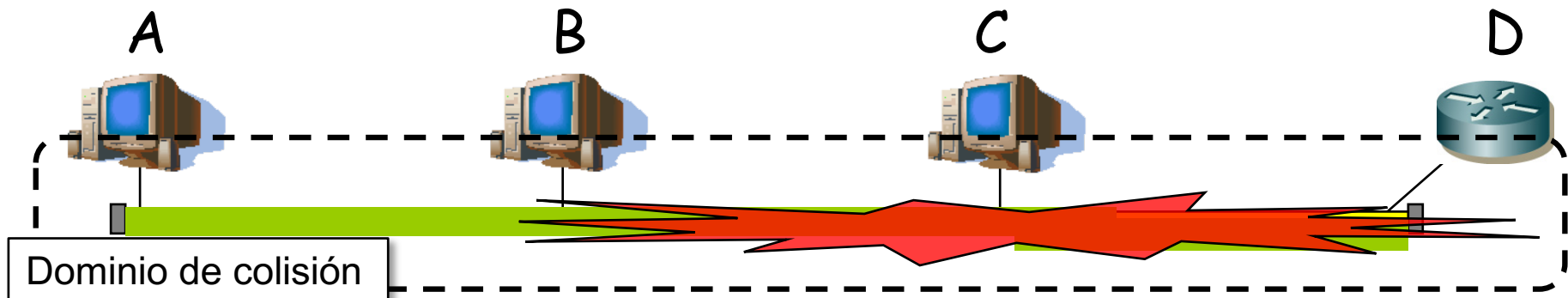
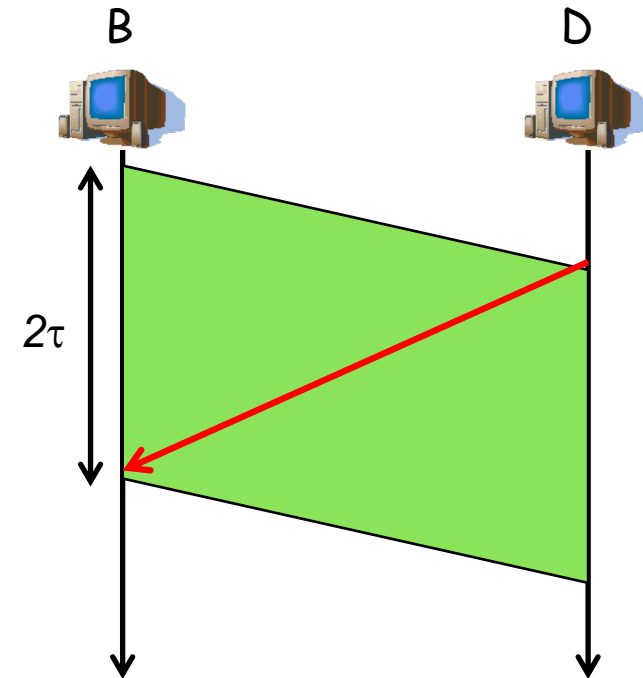

# Ethernet sobre coaxial fino

## 10Base2

- “Thinnet” o “Cheapernet”
- IEEE 802.3a
- Coaxial fino y flexible (negro)
- 2 → 185m (entre repetidores)
- Transceiver opcional (más barato)

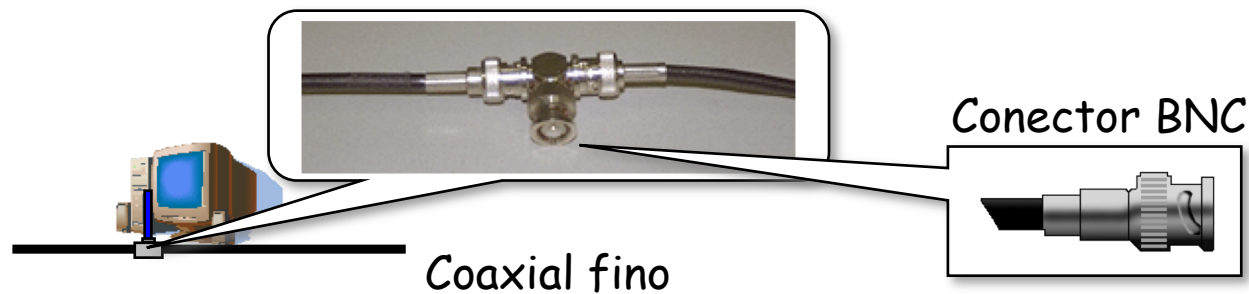
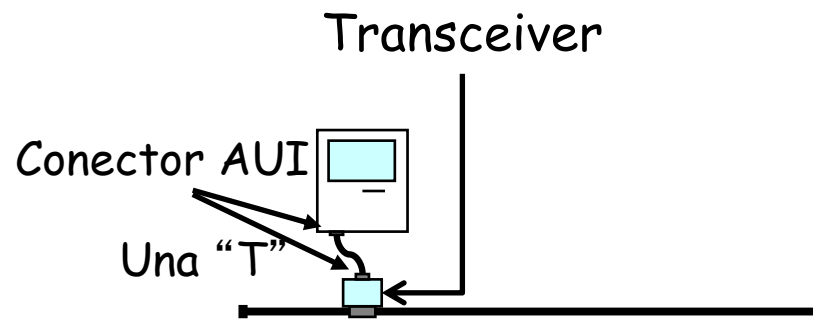
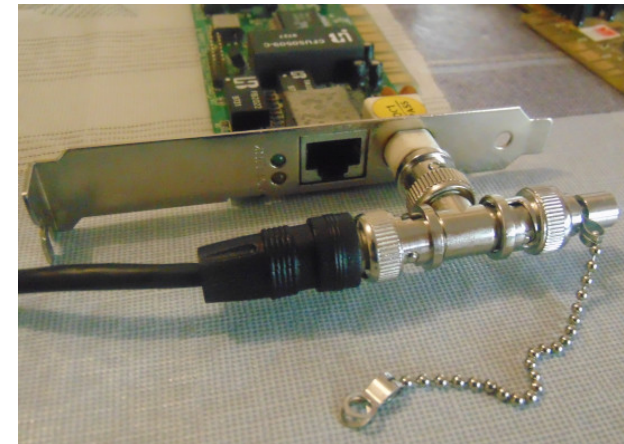

# Repetidores

- “Repetidor”
  - “Hub”
  - “Hub repetidor”
  - “Concentrador”
  - “Concentrador de cableado”
- Regeneración de la señal eléctrica
  - No tienen direcciones MAC
  - No modifican las tramas
  - En desuso, difíciles de encontrar
  - Su función la hacen switches
  - Ofrecían medio compartido interesante para captura de tráfico

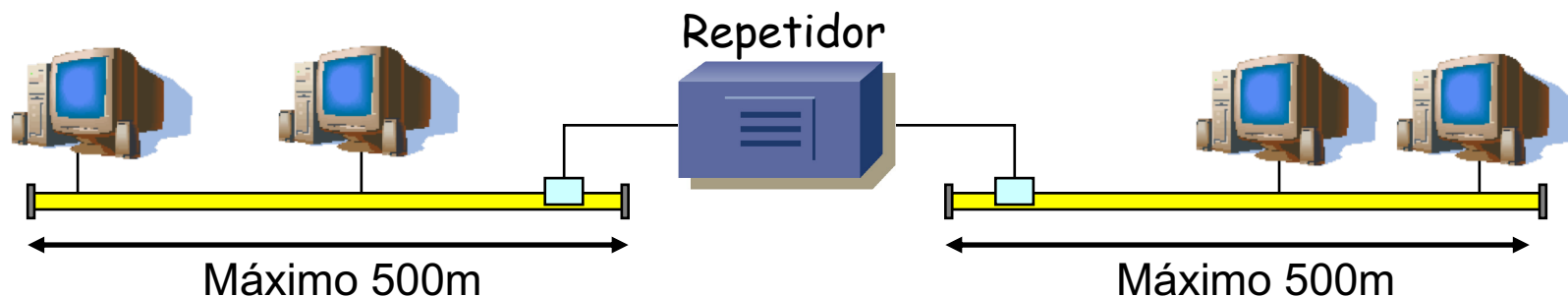
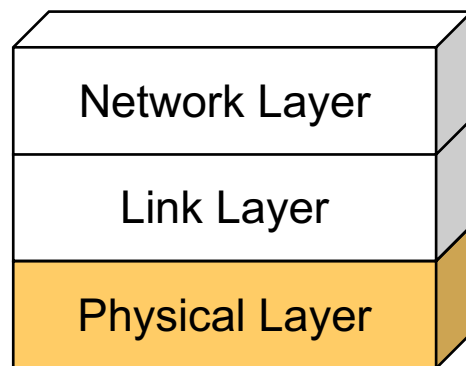

# Ethernet sobre pares de cobre

## 10Base-T

- IEEE 802.3i
- Cables de par trenzado al menos cat. 3
- Topología física en estrella
  - Elemento central = “Hub”
- Topología lógica en bus
- Transceiver opcional
- Conector RJ-45
- Cable máximo 100 m

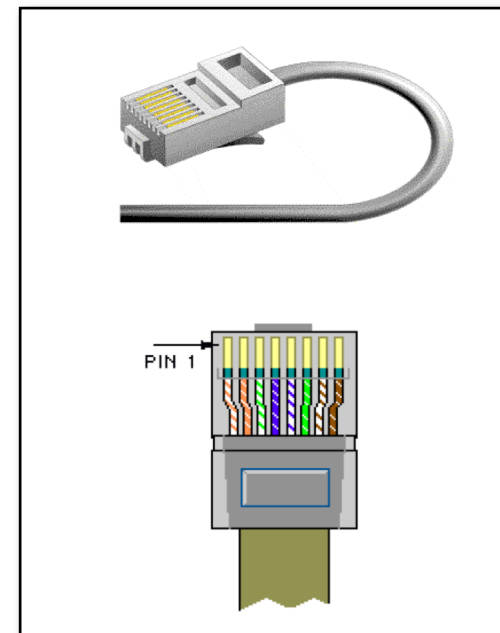

DTE = Data Terminal Equipment  
DCE = Data Communications Equipment

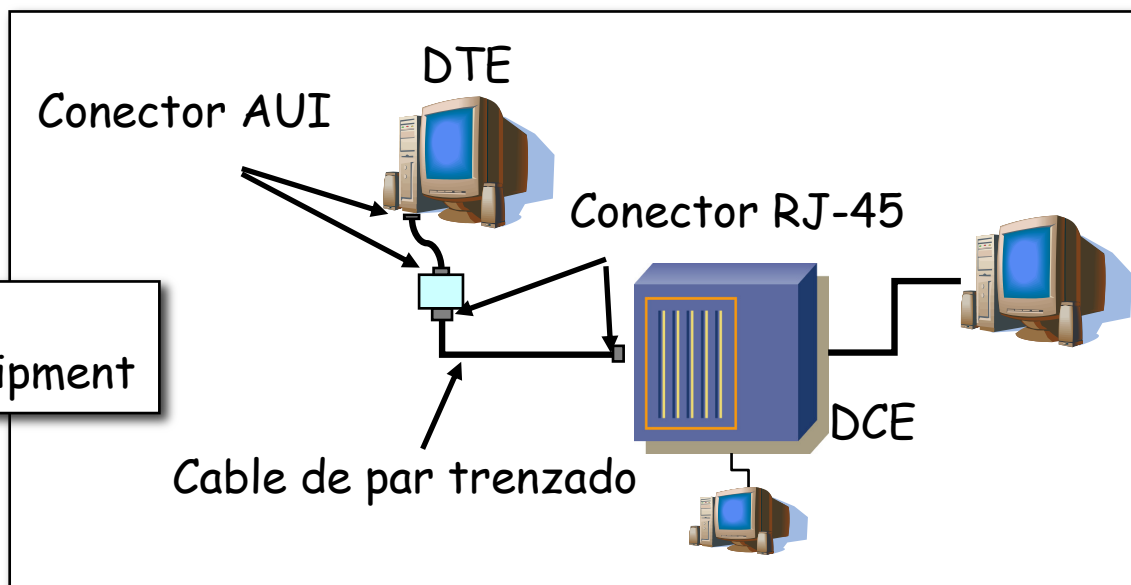

# Hubs Ethernet

- Ya no se venden
- Improbable que los encontréis instalados
- Apariencia externa igual que un switch Ethernet
- La diferencia es que el medio es compartido (CSMA/CD)
- Half-duplex



# Conexión de Hubs

- Nunca nunca nunca... forme un bucle

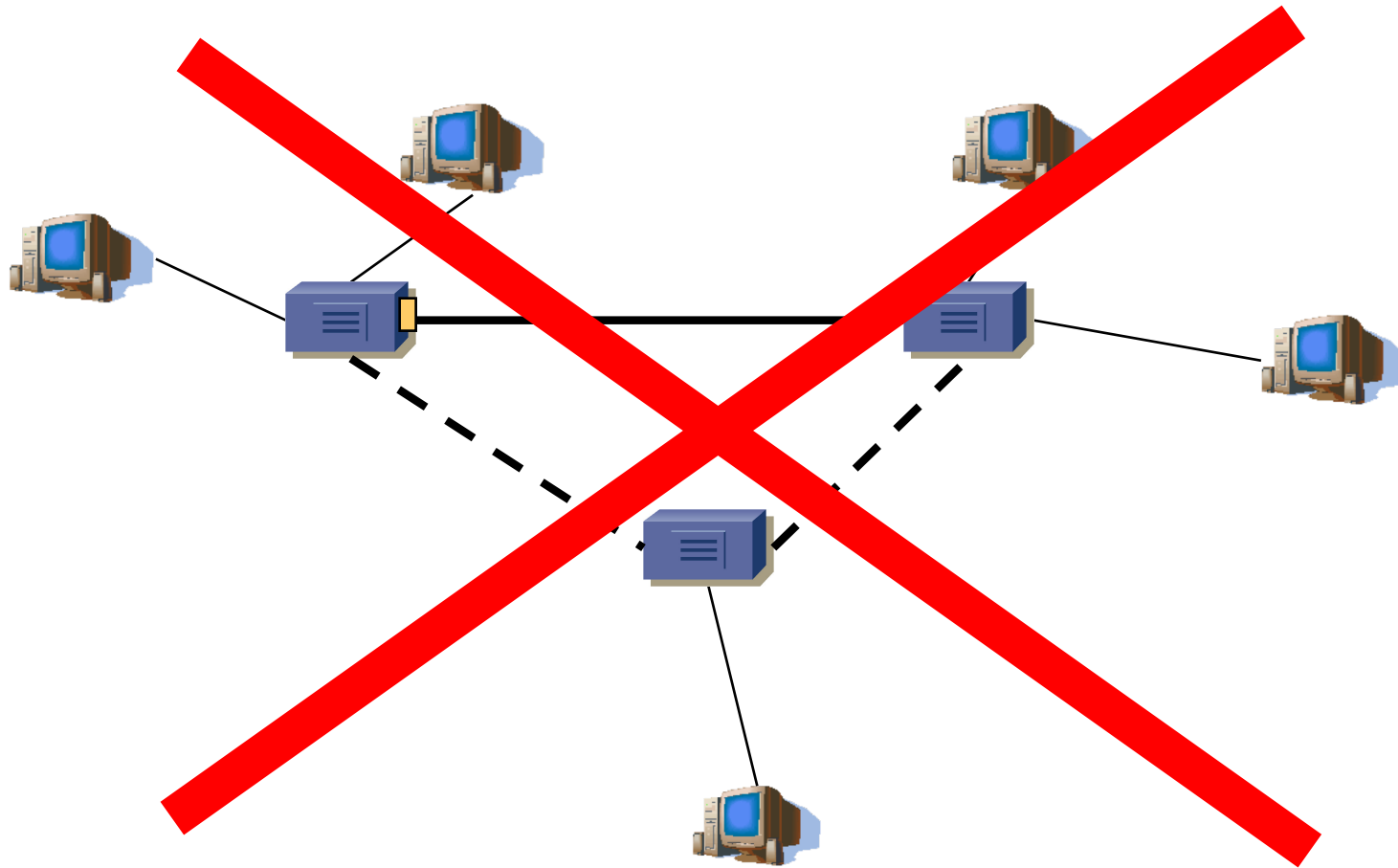



# Cable de par trenzado

- Ethernet 10Base-T emplea 2 pares, al menos categoría 3
- Un par transmisión, otro recepción
- En un hub las posiciones de los pares están intercambiadas

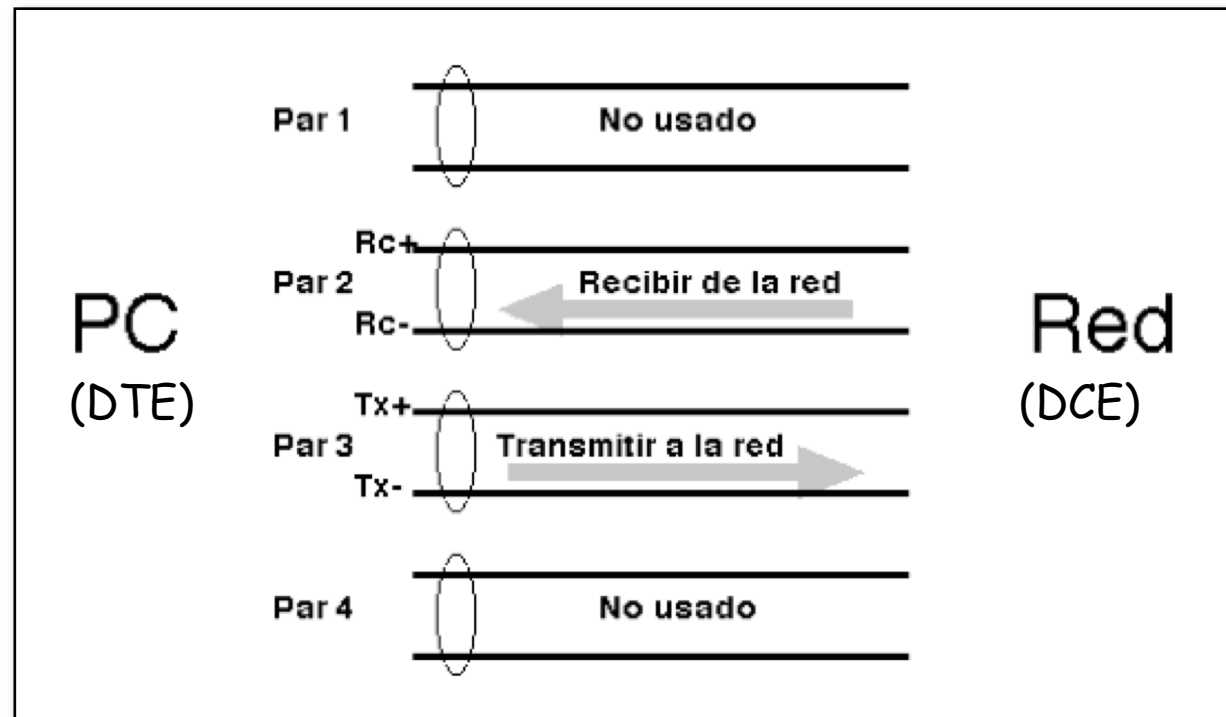

# Tecnologías Ethernet

- Para conectar dos PCs directamente se necesita un cable cruzado
- También entre dos hubs
- Un puerto de un router (conmutador capa 3) es como el de un PC

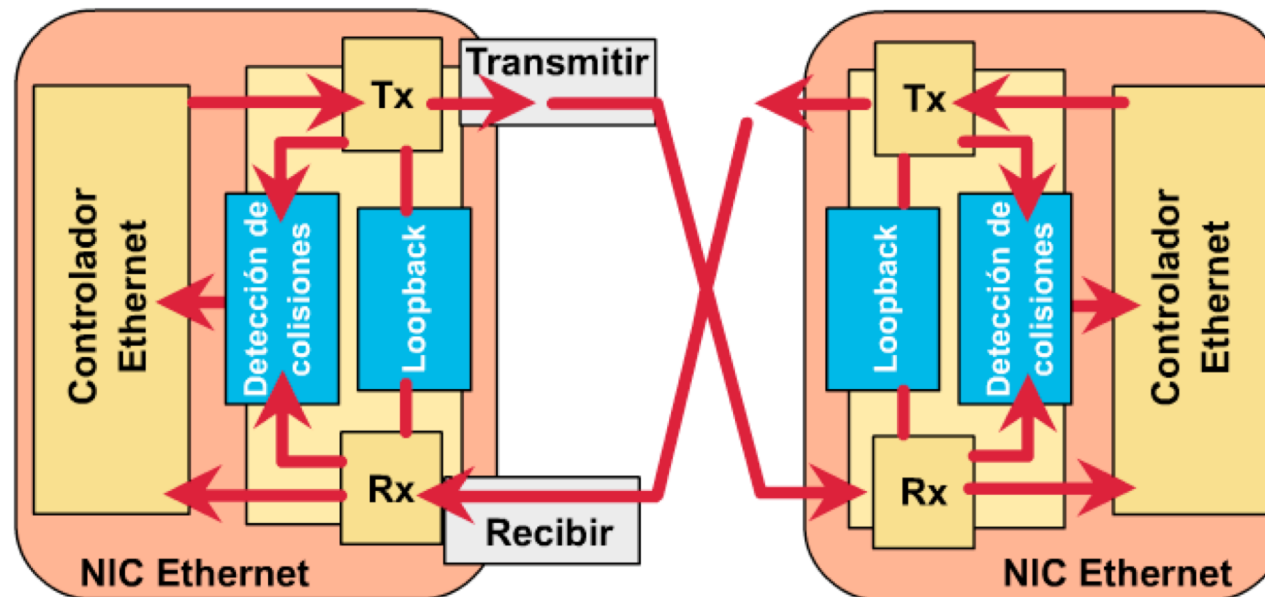
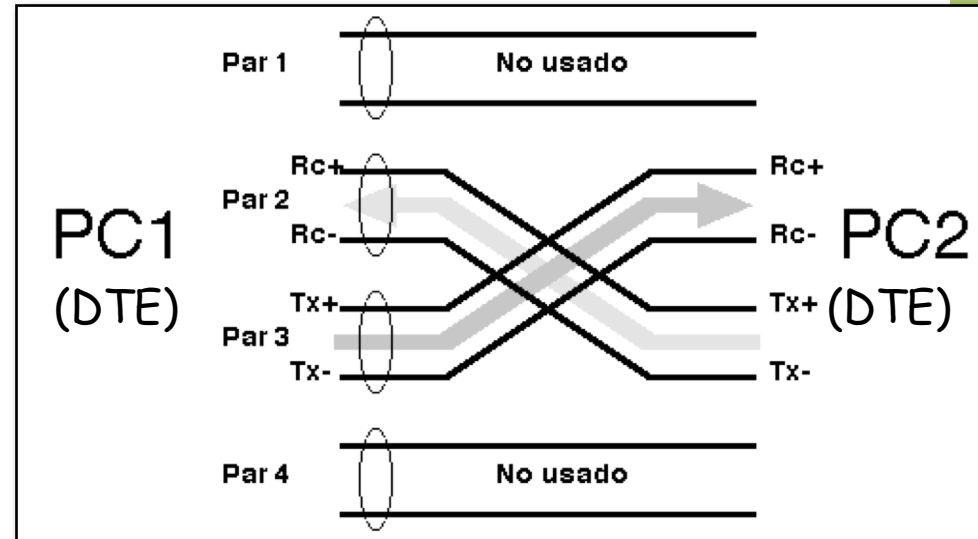

# Ethernet sobre fibra óptica

## 10BaseFL

- Fibra óptica multimodo (50 o 62.5  $\mu\text{m}$ )
- Dos hilos de fibra (lo más habitual en LAN)
- IEEE 802.3j
- Inmune a interferencias electromagnéticas
- Hasta 2 Km
- Usado en:
  - El *backbone* de una LAN
  - Cableado vertical
  - Larga distancia a un host

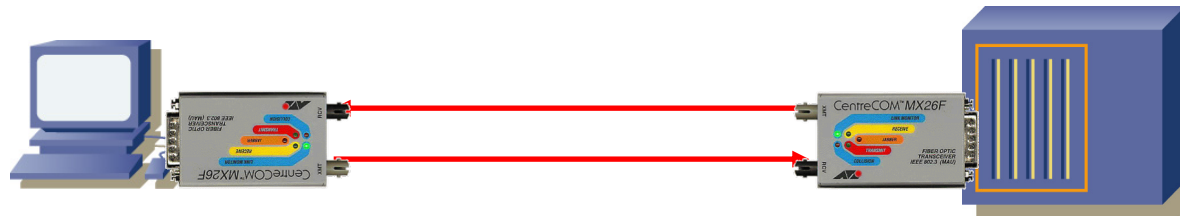

upna

Universidad Pública de Navarra  
Nafarroako Unibertsitate Publikoa



# Fast Ethernet



# Versiones 100Mb/s

- NO Coaxial
- Cable UTP cat.5 ó superior (100Base-TX)
- Fibra óptica (MM, 100BaseFX)

# Fast Ethernet

## 100Base-TX

- IEEE 802.3u
- MII = *Medium Independent Interface*
- Cables de par trenzado Cat.5 (100m)
- Usa 2 pares
- Transceiver opcional
- Conector RJ-45

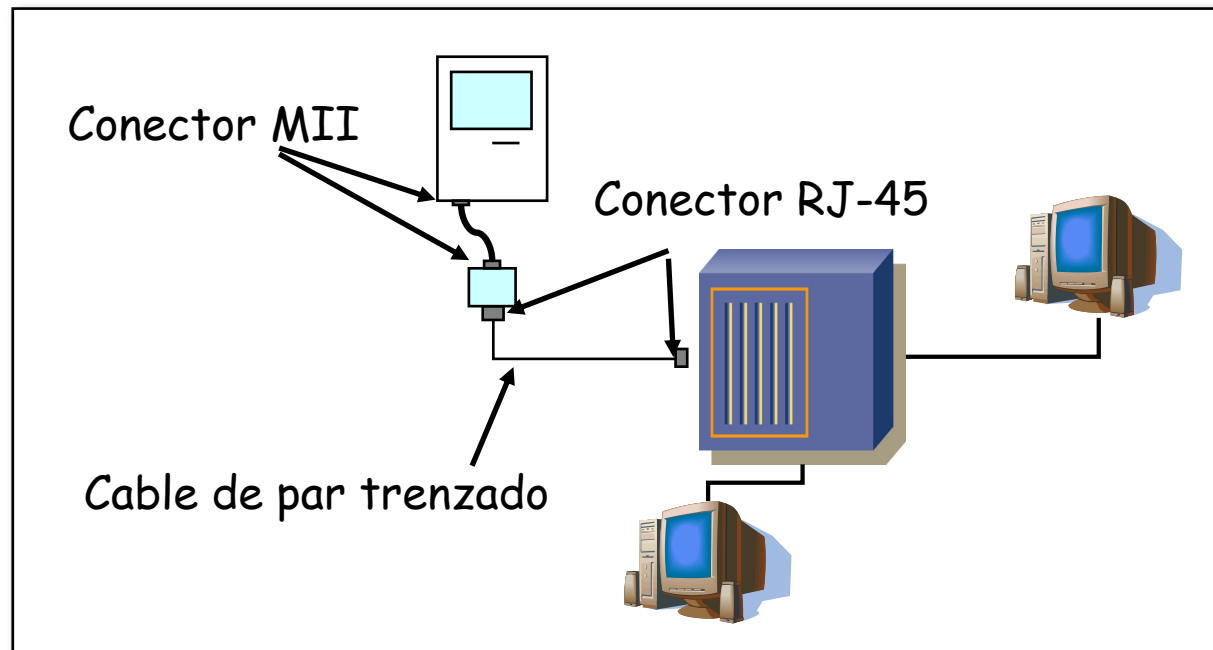
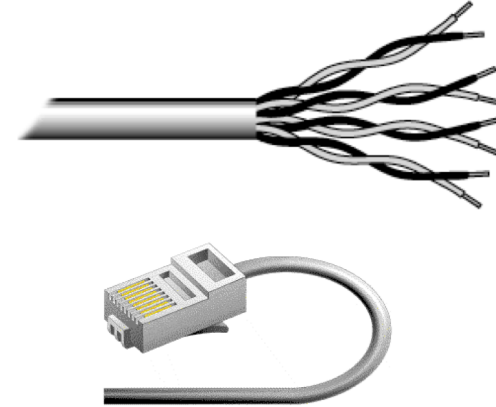

# Fast Ethernet

## 100Base-FX

- Fibra multimodo (50 ó 62.5  $\mu\text{m}$ )
- Dos hilos de fibra
- 2 Km (full-duplex)
- 412 m (half-duplex)

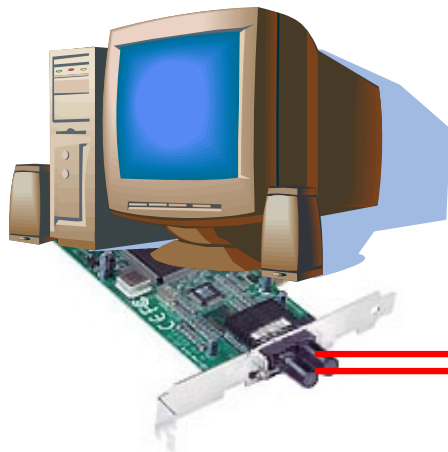
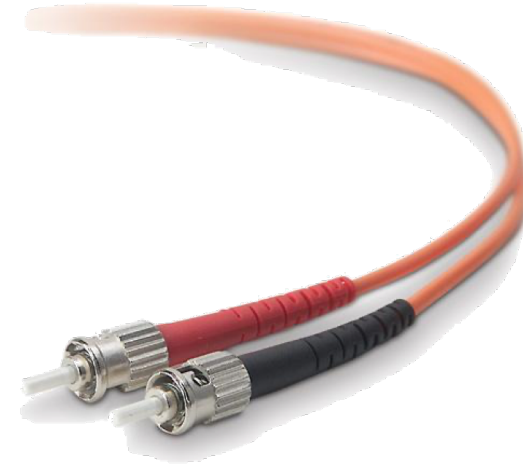

# Repetidores Fast Ethernet

- Solo 1 (ó 2) entre cualquier par de hosts con 100m al hub

## ¿ Por qué tan corta distancia ?

- CSMA/CD
- FastEthernet mantiene la longitud mínima de la trama (64 bytes)
- *Collision Window* ↓ (menor tiempo de transmisión)
- Elección: Aumentar el tamaño mínimo o reducir el diámetro máximo
- Se redujo el diámetro: speed x10 ⇒ diámetro ÷10

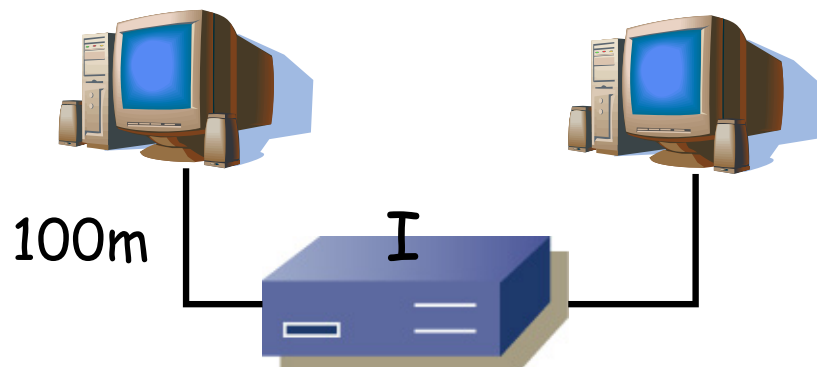
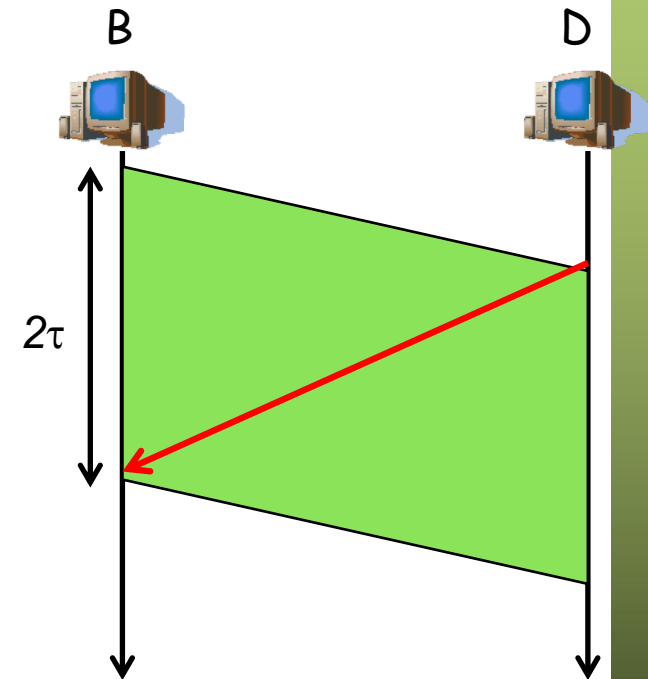

Tamaño de trama (bytes)	Tiempo de Tx (μseg) 10Mbps	Tiempo de Tx (μseg) 100Mbps
64	51.2	5.12
512	409.6	40.96
1000	800	80
1518	1214.4	121.44



# Autonegociación

- Opcional en IEEE 802.3u (Fast Ethernet)
- Extendida a 10Base-T
- Obligatorio en 1000Base-T
- Permite negociar:
  - Half/Full-Duplex
  - 10/100/1000 Mbps
- Mediante pulsos que se envían cuando no hay tramas
- Si un extremo lo soporta y otro no:
  - Extremo que lo soporta puede detectar la velocidad
  - No detecta el *duplex* así que escoge *half-duplex*



upna

Universidad Pública de Navarra  
Nafarroako Unibertsitate Publikoa



# Gigabit Ethernet



# Versiones 1000Mb/s

- NO Coaxial
- Cable UTP cat.5 ó superior, 4 pares (1000Base-T)
- Fibra óptica (MM, 1000Base-SX, SM 1000Base-LX)

# Gigabit Ethernet

## 1000Base-T

- IEEE 802.3ab
- 4 pares Cat.5 (100m)
- El *hub* existe en el estándar pero no se utiliza

GMII = Gigabit Medium Independent Interface

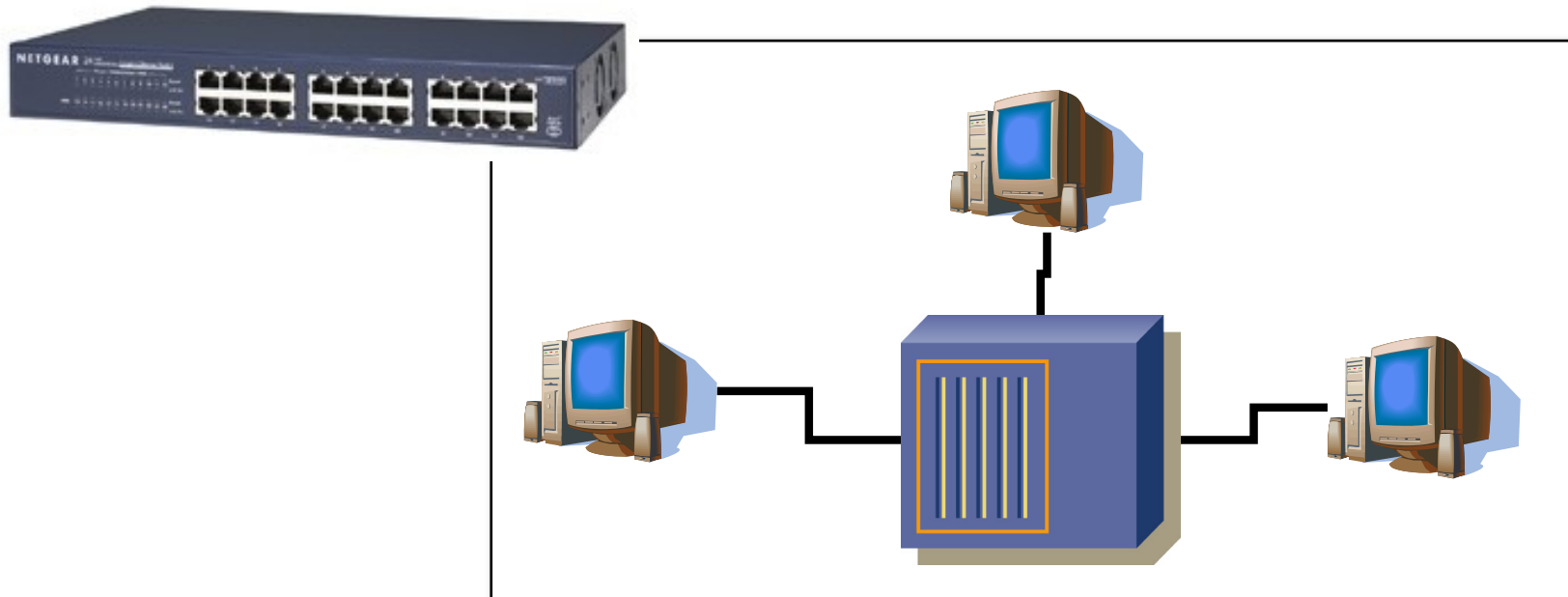

# Gigabit Ethernet

## 1000Base-X

- IEEE 802.3z
- 1000Base-SX : Fibra multimodo (200-500 m)
- 1000Base-LX : Fibra monomodo (5-10 Km)
- Otras variantes (según fabricante, durante procesos de estandarización, para primera milla, etc)

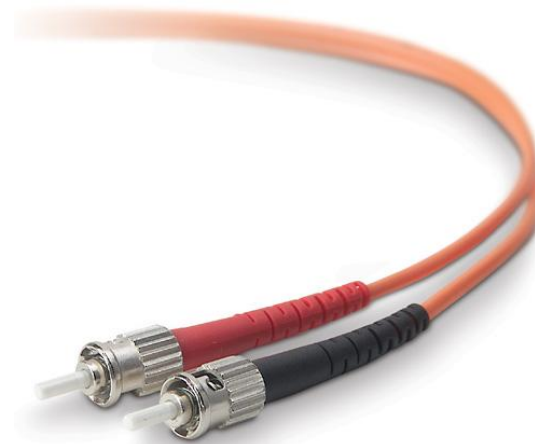
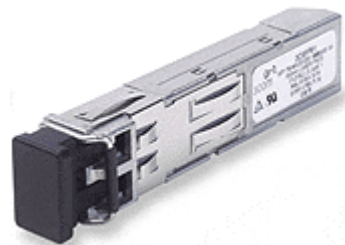

# Gigabit Ethernet

- Existe el *Hub* Gigabit
- Velocidad x10 frente a FastEthernet
- ¿ Diámetro ÷10 ?

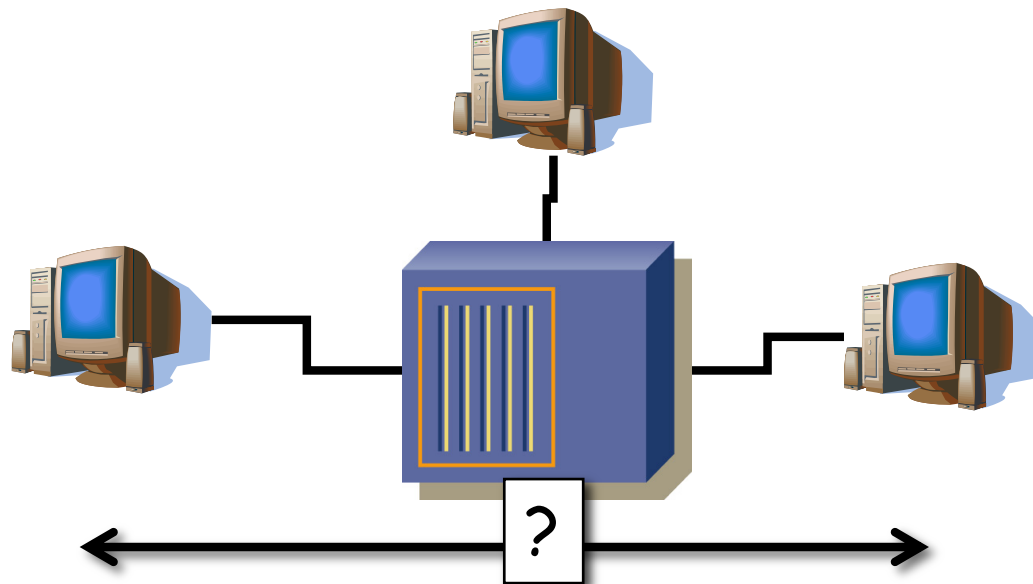

# Gigabit Ethernet

- ¿ Diámetro ÷10 ? NO

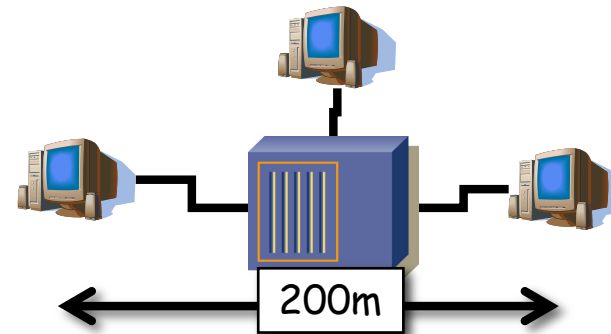

## **Carrier Extension**

- Mínimo tamaño 512 Bytes

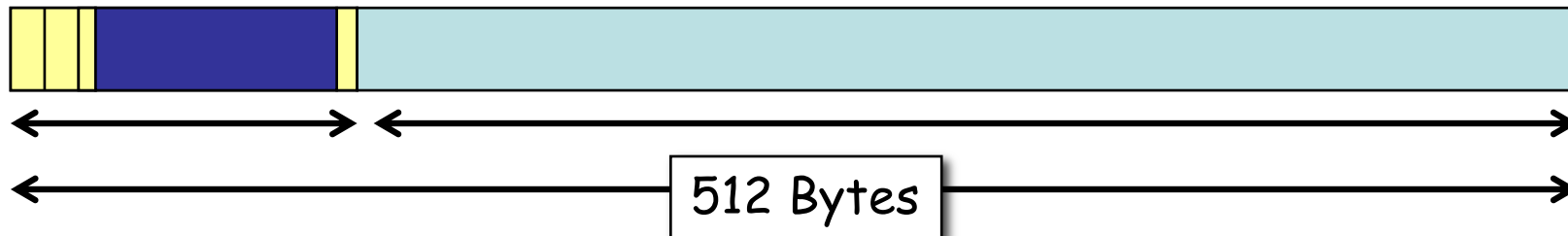

## **Frame Bursting**

- Puede transmitir varias tramas seguidas
- Sin liberar el canal
- Hasta 8192 bytes
- La primera trama, si es demasiado corta, requiere extensión de portadora

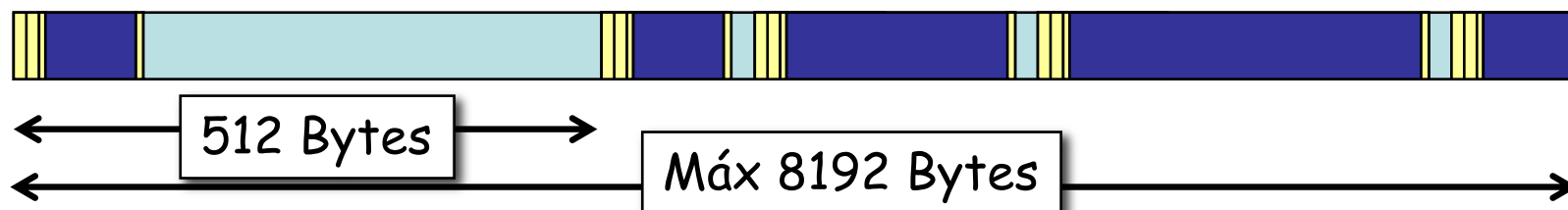

# Gigabit Ethernet

- Se emplean switches (próxima clase)
- Full Duplex
- No-CSMA/CD
- Así que no hacen falta las extensiones





# Gigabit Ethernet

## SFP

- Small Formfactor Pluggable transceiver
- Antes GBICs: GigaBit Interface Converter
- *Hot-swappable Transceiver*

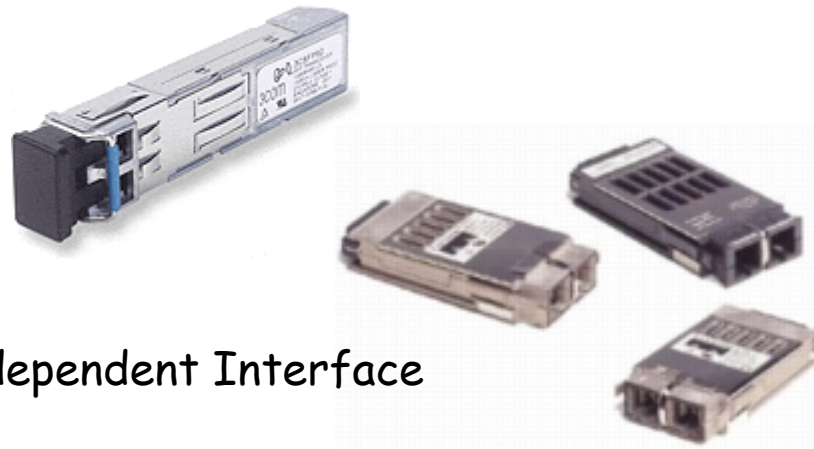

GMII = Gigabit Medium Independent Interface



# Gigabit Ethernet

## ¿ *Jumbo Frames* ?

- MTU tradicional 1500 bytes
- *Jumbo Frames* la aumentan a unos 9 KBytes
- Reduce la carga de procesamiento (pkts/sec)



upna

Universidad Pública de Navarra  
Nafarroako Unibertsitate Publikoa



# Equipos



# NIC

- [https://eu.dlink.com/es/es/-/media/business\\_products/dge/dge-528t/datasheet/dge\\_528t\\_c1\\_datasheet\\_en.pdf](https://eu.dlink.com/es/es/-/media/business_products/dge/dge-528t/datasheet/dge_528t_c1_datasheet_en.pdf)

## Product Highlights

### Upgrade to Gigabit

Enjoy lightning-fast data rates of up to 2 Gbps with a simple, economical upgrade

### Saves Power Automatically

Consumes less energy by automatically lowering power consumption when traffic is low

### Remote Bootup

Support for ACPI 2.0 Wake-on-LAN allows you to boot your PC remotely for convenient access and management

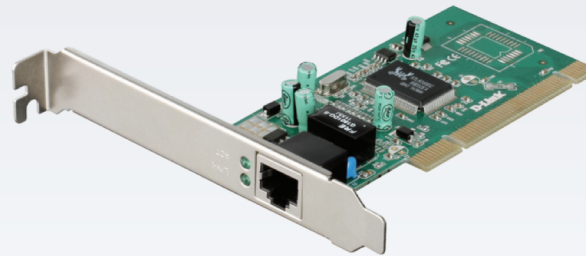

## Features

### High-Performance:

- 10/100/1000 Mbps
- Auto-Negotiation
- PCI Interface
- Plug-and-Play

### Advanced Standards Based Enterprise Features:

- IEEE 802.1p Priority Tagging
- IEEE 802.1Q VLAN Tagging
- IEEE 802.3x Flow Control
- Jumbo Frame Support (up to 7K bytes)
- ACPI 2.0 WOL Power Management

# Módulo SFP o SFP+

- [https://eu.dlink.com/es/es/-/media/business\\_products/dem/dem-431xt/datasheet/dem\\_400-series-datasheet-en-eu.pdf](https://eu.dlink.com/es/es/-/media/business_products/dem/dem-431xt/datasheet/dem_400-series-datasheet-en-eu.pdf)

## Product Highlights

### Covers Vast Distances

Support for maximum fibre lengths of up to 10 km, ideal for businesses spanning multiple premises, as well as copper lengths of up to 30 m

### High Performance

Full duplex Gigabit data transfer rates provide the network transmission speeds that business environments demand

### Hot Pluggable

Easily switch out transceivers while the power is on, facilitating network maintenance and minimising downtime

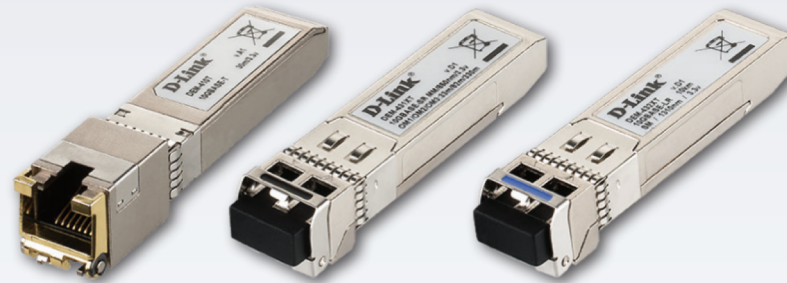

## DEM-400 Series

## 10 Gigabit SFP Transceivers

## Features

- Enhanced Small Form-Pluggable (SFP+) form factor
- Hot pluggable
- Support 10G Ethernet
- Support fibre cables up to 10 km
- Support copper cables up to 30 m
- RoHS Compliant
- Compliant with MSA (Multiple Source Agreement)
- Compliant with IEEE802.3ae standard

# Puertos para módulo SFP/SFP+

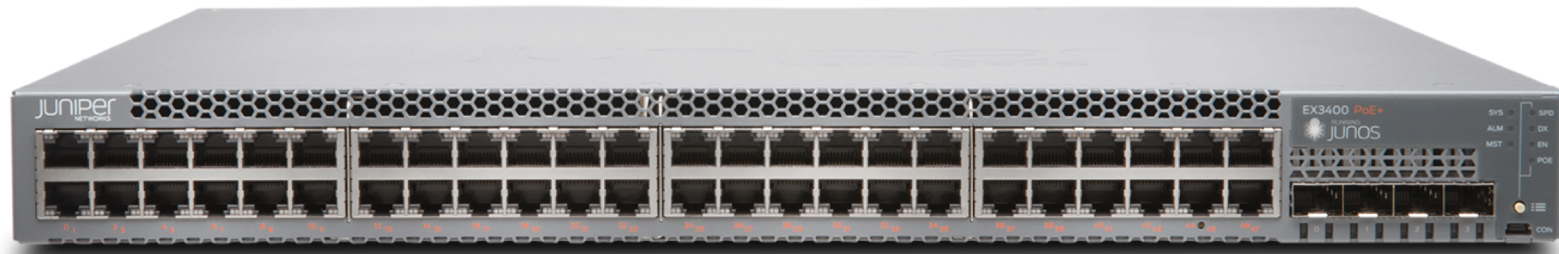

upna

Universidad Pública de Navarra  
Nafarroako Unibertsitate Publikoa



# Ethernet > 1Gbps



# Ethernet a 10Gb/s

## 10GBase-X

- IEEE 802.3ae
- 10GBase-SR : F.O. Multimodo (30-300m)
- 10GBase-LR : F.O. Monomodo (10-20Km)
- 10GBase-ER : F.O. Monomodo (40Km)
- 10GBase-SW/LW/EW : WAN PHY (9.58Gbps), para mapearse directamente en un contenedor SONET/SDH (VC-4-64c)





# Ethernet a 10Gb/s

## 10GBase-T

- IEEE 802.3an
- Cable Categoría 6 (55m)
- Cable Categoría 6 aumentada o Cat.7 (100m)
- 10 Gigabit Ethernet solo Full-Duplex



# Otras velocidades

- 40 Gb/s, IEEE 802.3ba (2010)
  - Backplane (1m, solo 40Gb/s), cobre (10m) y fibra óptica
  - Emplea varias wavelenghts, Ejemplo: 40GBASE-LR4
- 100 Gb/s, IEEE 802.3ba (2010)
  - Fibra óptica
- 2.5 Gb/s y 5 Gb/s, 802.3bz (2016)
  - “Multigigabit Ethernet”
  - Cat. 5e y 6
- 25 Gb/s, 802.3by (2016)
  - Cable twinaxial y fibra óptica
- 200 Gb/s y 400 Gb/s, 802.3bs (2017), 802.3cm (2020)
  - Fibra óptica
- 50 Gb/s, 802.3cn (2019)
  - Fibra óptica